

JANSEN-ECONOMY 50 RS

RAUCHSCHUTZTÜREN NACH DIN 18095 (EN 1634-3)
AUS STAHL UND EDELSTAHL

JANSEN-ECONOMY 50 RS

SMOKE CONTROL DOORS ACCORDING TO DIN 18095 (EN 1634-3)
IN STEEL AND STAINLESS STEEL

Grafische Planungsdaten wie z.B. Anwendungsbeispiele, Konstruktionsdetails, Anschlüsse am Bau, die in unseren physischen oder elektronischen Dokumentationsunterlagen enthalten sind, sind schematische Darstellungen. Gleiches gilt für digitale Medien wie CAD Dateien oder BIM Modelle.

Sie sollen den ausführenden Metallbauer und/oder Fachplaner bei der Planung und Ausführung eines Projektes unterstützen. Sie sind im konkreten Anwendungsfall durch den ausführenden Metallbauer und/oder Fachplaner auf die Verwendbarkeit im konkreten betroffenen Projekt hinsichtlich rechtlichen/regulatorischen aber auch technischen objektspezifischen Anforderungen zu überprüfen und ggfs. eigenverantwortlich anzupassen.

Bei der Überprüfung, der spezifischen Planung und der Umsetzung sind die objektspezifischen Rahmenbedingungen (Material der Bausubstanz, Dimension des Einbauelements, Farbe, Exposition, Lasteinwirkung, etc.) sowie der geltende Stand der Technik einschliesslich aller anwendbaren Normen und technischen Richtlinien eigenverantwortlich zu beachten.

Falls das vorliegende Dokument Differenzen zur aktuellen deutschen Version (Artikel Nr. K1214226) aufweist, gilt in jedem Fall der deutsche Originaltext in der jeweils geltenden Fassung im Jansen Docu Center.

Alle Ausführungen dieser Dokumentation haben wir sorgfältig und nach bestem Wissen zusammengestellt. Wir können aber keine Verantwortung für die Benutzung der vermittelten Vorschläge und Daten übernehmen. Wir behalten uns technische Änderungen ohne Vorankündigung vor.

Les données de planification graphiques, comme les exemples d'application, détails de construction et raccordements au bâtiment, fournies dans notre documentation physique et numérique sont des représentations schématiques. Il en va de même pour les médias numériques comme les fichiers CAD ou modèles BIM.

Leur but est de faciliter la planification et réalisation d'un projet par les constructeurs métalliques et/ou concepteurs. Concrètement, elles doivent être vérifiées par le constructeur métallique et/ou le concepteur et, le cas échéant, modifiées de son propre chef pour s'assurer qu'elles concordent avec le projet concerné et qu'elles répondent aux exigences techniques spécifiques ainsi qu'aux dispositions légales et réglementaires.

Lors de la vérification, de la planification spécifique et de la mise en œuvre, il y a lieu de tenir compte des conditions spécifiques à l'objet (matériaux du bâtiment, dimension de l'élément d'insert, couleur, exposition, effet de charge, etc.) ainsi que de l'état actuel de la technique, y compris toutes les normes et directives techniques applicables.

En cas de divergence entre le présent document et la version allemande (no d'article K1214226), c'est dans tous les cas le texte original allemand qui prévaut dans sa version actuelle disponible dans le Jansen Docu Center.

Nous avons apporté le plus grand soin à l'élaboration de cette documentation. Cependant, nous déclinons toute responsabilité pour l'utilisation faite de nos propositions et de nos données.

Nous nous réservons le droit de procéder à des modifications techniques sans préavis.

Graphical planning data such as application examples, construction details, connections on site that are contained in our physical or electronic documentation components are schematic representations. The same applies to digital media such as CAD files or BIM models.

They are intended to support the metal worker and/or design engineer in planning and executing projects. In the specific case of application they are to be checked by the metal worker and/or design engineer in terms of their usability in the specific project concerned with regard to legal/regulatory and technical property-specific requirements and adjusted if necessary at the latter's own responsibility.

The property-specific underlying conditions (construction material, dimensions of installation element, colour, exposure, load effect etc.) and current state of the art including all applicable norms and technical guidelines are to be taken into consideration at the metal worker and/or design engineer's own responsibility during the review, specific planning and implementation.

If there are any differences between this document and the current German version (item number K1214226), the latest version of the original German text in the Jansen Docu Center shall prevail.

All the information contained in this documentation is given to the best of our knowledge and ability. However, we decline all responsibility for the use made of these suggestions and data.

We reserve the right to effect technical modifications without prior warning.

Systemübersicht

Merkmale
Zulassungen
Systemausführungen
Typenübersicht

Sommaire du système

Caractéristiques
Homologations
Exécutions de système
Sommaire des types

Summary of system

Characteristics
Authorisations
System versions
Summary of types

2

**Profilsortiment in Stahl
und Edelstahl**

**Assortiment de profilé
en acier et acier Inox**

**Range of profiles in
steel and stainless steel**

12

Beispiele

Schnittpunkte
Konstruktionsdetails
Anschlüsse am Bau

Exemples

Coupes de détails
Détails de construction
Raccords au mur

Examples

Section details
Construction details
Attachment to structure

18

Leistungseigenschaften

**Caractéristiques de
performance**

**Performance
characteristics**

30







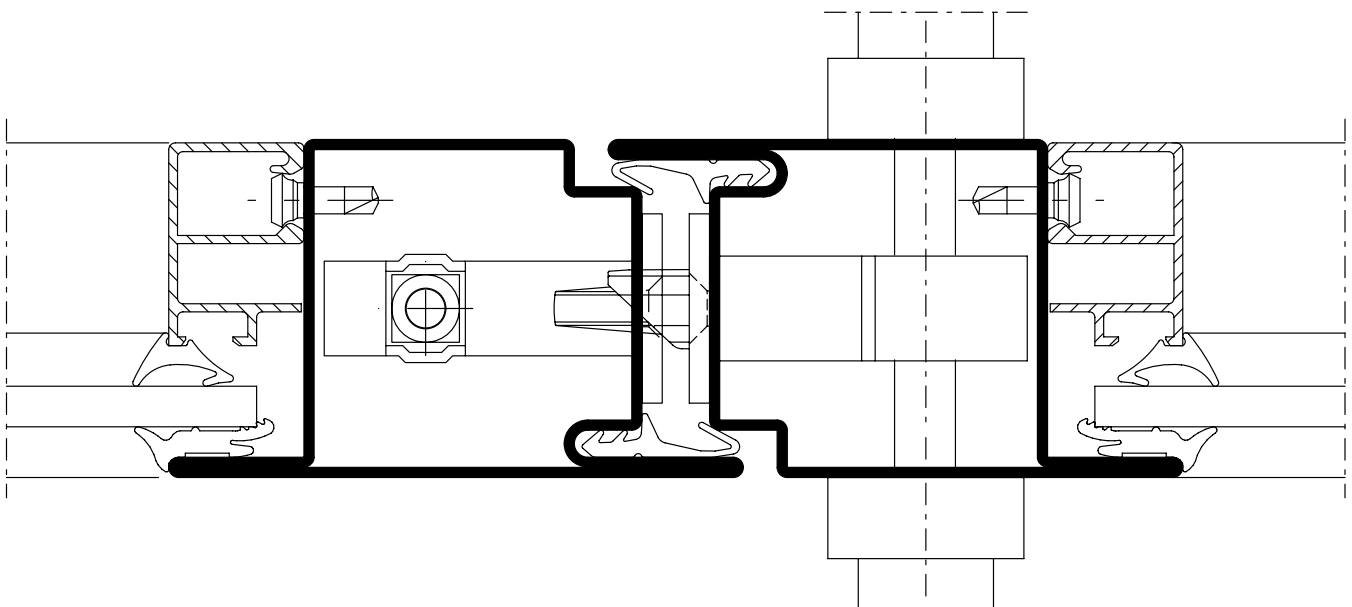

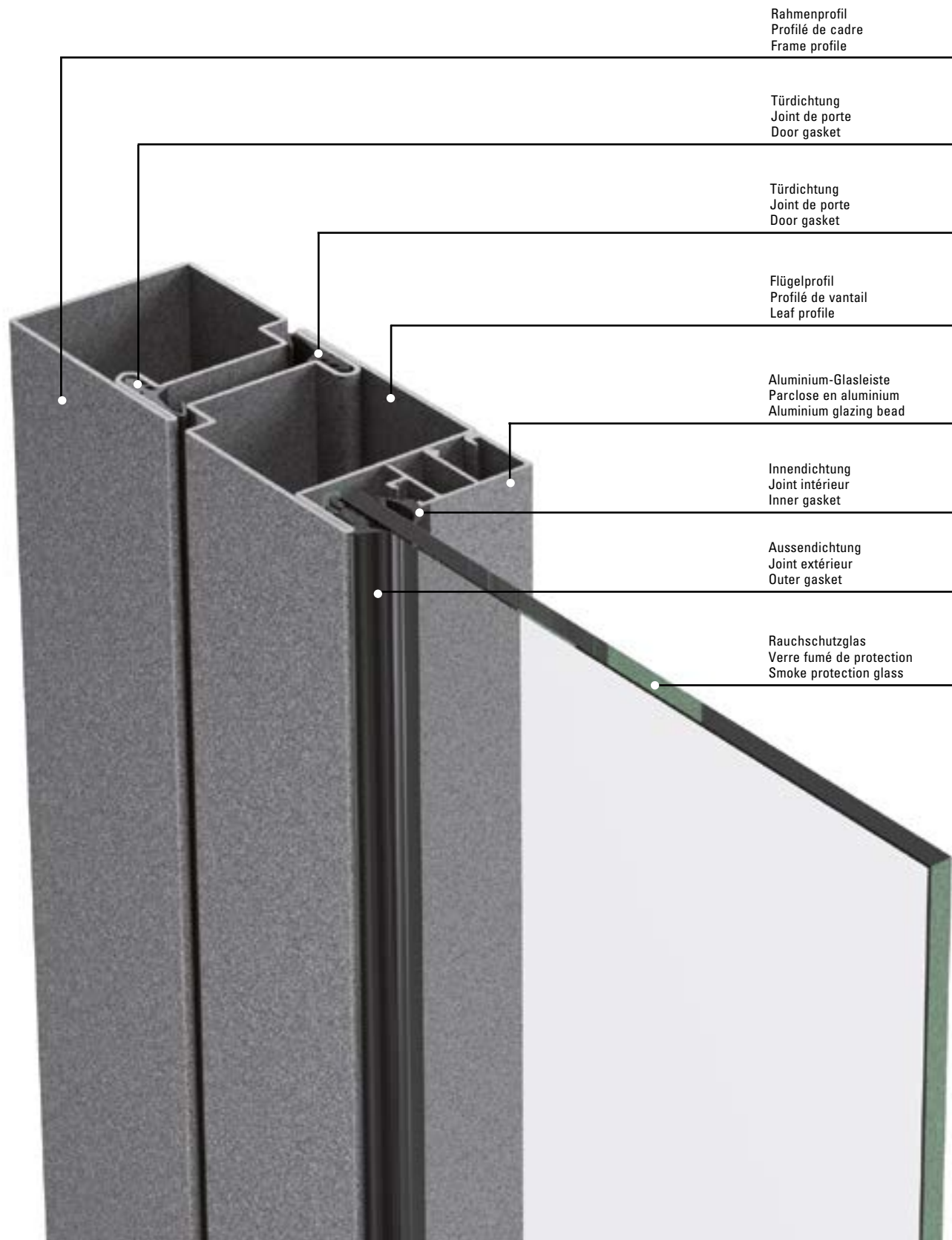
Merkmale
Caractéristiques
Characteristics



Jansen-Economy 50 RS
Jansen-Economy 50 RS
Jansen-Economy 50 RS

- Stahlsystem für Türen und Festverglasungen
- Bautiefe 50 mm, innen und aussen flächenbündig
- Schmale Ansichtsbreiten: Rahmen und Flügel ab 107,5 mm Stulppartie 155 mm
- Ein- und zweiflüglige Türen, nach innen und aussen öffnend, mit oder ohne Seitenteile und Oberlichter sowie Trennwände
- Türflügel bis 1750 x 3750 mm (BxH), landesspezifische Zulassung beachten
- Füllelementstärke von 5 bis 27 mm, Glaseinbau mittels Trocken- oder Nassverglasung
- Systemprüfungen nach Produktnorm EN 14351-1
- Stahlprofile blank oder bandverzinkt
- Grosses Sortiment an systemgeprüften Türbeschlägen
- Barrierefreie Schwellenausbildungen
- Geeignet für Pulver- und Nasslackbeschichtungen
- Rauchschutztüre gemäss EN 1634-3 und EN 16034
- Système en acier pour portes et vitrages fixes
- Profondeur de montage 50 mm, montage à fleur à l'intérieur et à l'extérieur
- Fines largeurs de face: Cadre et vantaux à partir de 107,5 mm Partie tête 155 mm
- Portes à un et deux vantaux, ouverture vers l'intérieur et vers l'extérieur, combinables avec parties latérales, impostes et vitrage fixe
- Vantaux de porte jusqu'à 1750 x 3750 mm (LaxH), il convient de respecter les prescriptions et règlements des divers pays concernés
- Élément de remplissage de 5 à 27 mm d'épaisseur, Montage du vitrage à sec ou à silicone
- Contrôles des systèmes selon la norme produit EN 14351-1
- Profilés en acier brut ou galvanisé en continu
- Grand assortiment de ferrures de porte homologuées
- Formes de seuil sans barrière
- Convient aux revêtements par poudre ou peinture liquide
- Porte coupe-fumée EN 1634-3 et EN 16034
- Steel system for doors and fixed glazing
- 50 mm basic depth, flush-fitted on the inside and outside
- Narrow face widths: Frame and leaf from 107.5 mm Meeting stile assembly 155 mm
- Single and double-leaf doors, inward and outward-opening, can be combined with side-lights, toplight or fixed glazing
- Door leaf up to 1750 x 3750 mm (WxH), the regulations and bye-laws in force in the particular country must be respected
- Infill unit thickness of 5 to 27 mm, Glazing installed by means of dry or wet glazing
- System tests in accordance with
- Raw finish or strip galvanised steel profiles
- Large range of system-tested door fittings
- Easy-access thresholds
- Suitable for powder and wet paint coating
- Smoke-proof door according to EN 1634-3 and EN 16034





Norm	Eigenschaft Caractéristique Characteristic	Klassifizierung/Wert Classification / Valeur Classification / Value										
 EN 12210	Widerstandsfähigkeit bei Windlast Résistance à la pression du vent Resistance to wind load	npd	1 (400)	2 (800)	3 (1200)	4 (1600)	5 (2000)	Exxx (>2000)				
 EN 12208	Schlagregendichtheit Etanchéité à la pluie battante Watertightness	npd	1A (0)	2A (50)	3A (100)	4A (150)	5A (200)	6A (250)	7A (300)	8A (450)	9A (600)	Exxx (>750)
 EN ISO 10140	Schalldämmung R_w (C, C_{tr}) (dB) Isolation phonique R_w (C, C_{tr}) (dB) Sound insulation R_w (C, C_{tr}) (dB)	npd	bis R_w 44 dB (-2; -5) jusqu'à R_w 44 dB (-2; -5) up to R_w 44 dB (-2; -5)									
 EN ISO 10077-2	Wärmedurchgangskoeffizient U_f (W/(m ² ·K)) Transmission thermique U_f (W/(m ² ·K)) Thermal production U_f (W/(m ² ·K))	npd	ab 5.65 W/m ² K à partir de 5.65 W/m ² K from 5.65 W/m ² K									
 EN 12207	Luftdurchlässigkeit Perméabilité à l'air Air permeability	npd	1 (150)		2 (300)		3 (600)		4 (600)			
 EN 1192	Klassifizierung der Festigkeitsanforderungen Classification des exigences de résistance méc. Classification of strength requirements	npd	1		2		3		4			
 EN 1522	Durchschusshemmung Résistance aux balles Bullet proofing	npd	FB1	FB2	FB3	FB4	FB5	FB6	FB7	FSG		
 EN 1191 EN 1603	Dauerfunktionsprüfung Durabilité mécanique Mechanical durability		D	1 5'000	2 10'000	3 20'000	4 50'000	5 100'000	6 200'000	7 500'000	8 1'000'000	
 EN 179 EN 1125	Fähigkeit zur Freigabe Capacité au déclenchement Ability to release		Anforderung erfüllt Exigence remplie Requirement fulfilled									

Norm	Eigenschaft Caractéristique Characteristic	Klassifizierung/Wert Classification / Valeur Classification / Value
 EN 1634-3	Rauchschutz Etanchéité à la fumée Smoke control	S _a / S ₂₀₀
 EN 16034 EN 13501-2	Selbstschiessung Fermeture automatique Self-closing	C
 EN 16034	Dauerhaftigkeit der Selbstschiessung gegenüber Alterung (Korrosion) Endurance de la fermeture automatique contre le vieillissement (corrosion) Durability of self-closing against ageing (corrosion)	erzielt atteinte achieved



Fluchttürsysteme

- Fluchttürsysteme geeignet für Notausgänge und Paniktüren
- Fluchttürnorm EN 179 für Notausgangsverschlüsse erfüllt
- Fluchttürnorm EN 1125 für Panikverschlüsse erfüllt

Systèmes de porte de secours

- Systèmes de porte de secours pour issues de secours et portes panique
- Norme relative aux portes de secours EN 179, remplie pour les fermetures d'issue de secours
- Norme relative aux portes de secours EN 1125, remplie pour les fermetures panique

Emergency exit systems

- Emergency exit systems suitable for emergency exits and panic doors
- Emergency exit standard EN 179 for emergency exit devices fulfilled
- Emergency exit standard EN 1125 for panic exit devices fulfilled



Jansen-Economy 50 RS Edelstahl

- Werkstoff 1.4404
- Für ein- und zweiflüglige Brandschutztüren mit oder ohne Seitenteile bzw. Oberlicht
- Für Brandschutztrennwände
- Für Aussenanwendungen
- Schlanke Rahmen und Türprofile mit nur 50 mm Bautiefe

Jansen-Economy 50 RS acier Inox

- Matériaux 1.4404
- Pour portes coupe-feu à un/deux vantaux avec ou sans pièces latérales ou imposte
- Pour cloisons coupe-feu
- Pour l'extérieur
- Cadres et profilés de porte fins avec une profondeur de montage de seulement 50 mm

Jansen-Economy 50 RS stainless steel

- Material 1.4404
- For single and double-leaf fire doors with or without sidelight/toplight
- For fire wallse
- For external usen
- Narrow frames and door profiles with just 50 mm basic depth



Verblechte Jansen-Economy 50 RS Türen

- Für ein- und zweiflügelige Brandschutztüren mit oder ohne Seitenteile resp. Oberlichter
- Flächenbündig verblechte Türen
- Bleche können an den Rahmen geschweisst oder geklebt werden
- Mit oder ohne Glasausschnitte möglich

Portes tôlées Jansen-Economy 50 RS

- Pour des portes coupe-feu à un/deux vantaux avec ou sans pièces latérales ou impostes
- Portes tôlées à fleur
- Les tôles peuvent être soudées ou collées sur le cadre
- Possibles avec ou sans panneaux de verre

Jansen Economy 50 RS sheet metal doors

- For single and double-leaf fire doors with or without sidelights or toplights
- Flush-fitted sheet metal doors
- Sheet metal can be welded or bonded to the frame
- Possible with or without glass vision panels

Jansen Docu Center

Die Plattform zum effizienten Arbeiten mit Jansen Dokumentationen. Im Jansen Docu Center stehen alle Produktinformationen jederzeit digital in der aktuellsten Version zur Verfügung: von Architekten-Informationen über Bestell- und Fertigungskatalogen bis hin zu Anleitungen und Prospekten sowie Videos.

Die Inhalte können einfach und schnell aufgerufen werden. Ein für den Anwender komfortables papierloses Arbeiten, das zahlreiche Vorteile bietet.

Download CAD Daten

DXF

DWG

Sie können die Zeichnungen in den Formaten DXF und/oder DWG herunterladen. Klicken Sie auf das entsprechende Icon und der Download erfolgt.

Die Hinweise «Artikelbibliothek/Türbeschläge/Fensterbeschläge» bedeuten, dass Sie mit einem Klick die gesamte Artikelbibliothek des entsprechenden Systems herunterladen (Profile, Beschläge, Glasleisten, Zubehör etc.).

Info und Beratung

Gerne beraten wir Sie persönlich und stehen Ihnen bei Fragen zur Verfügung. Bitte schreiben Sie uns Ihre Anliegen an: info@jansen.com

Jansen Docu Center

La plate-forme pour travailler efficacement avec les documentations Jansen. Le Jansen Docu Center met à votre disposition les informations sur les produits, en format numérique et dans une version actualisée: des catalogues de commande et de fabrication aux instructions et prospectus, en passant par les informations destinées aux architectes et vidéos.

Les contenus sont facilement et rapidement accessibles. Une manière de travailler confortable et offrant de nombreux avantages.

Télécharger fichiers DAO

DXF

DWG

Vous pouvez télécharger les dessins aux formats DXF et/ou DWG. Cliquez sur l'icône correspondante et le téléchargement s'effectuera.

Les indications «Bibliothèque des articles/Ferures de porte/Ferrures de fenêtres» signifie que vous téléchargez la totalité de la bibliothèque des articles du système donné (profilés, ferrures, parcloles, accessoires etc.).

Info et conseils

Nous vous conseillons volontiers individuellement et sommes à votre disposition si vous avez des questions à poser. Veuillez nous envoyer votre requête à: info@jansen.com

Jansen Docu Center

The platform for working efficiently with Jansen documentation. The latest version of all the product information is available digitally at any time in the Jansen Docu Center – from order and fabrication manuals to architect information, instructions and brochures and videos.

The content can be retrieved quickly and easily. The user can work conveniently without paper, which has numerous benefits.

Download CAD files

DXF

DWG

You can download the drawings in DXF and/or DWG format. Click on the relevant icon to begin the download.

The items «Article library/Door fittings/Window fittings» means that you download the entire article library for the corresponding system with one click (profiles, fittings, glazing beads, accessories etc.).

Information and advice

We would be delighted to provide you with advice in person and are available to answer any questions you may have. Please write to us with your queries at: info@jansen.com

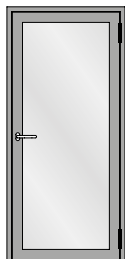

Einflügelige Türe
 Porte à un vantail
 Single leaf door

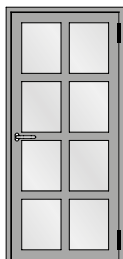

Einflügelige Türe mit Riegel
 Porte à un vantail avec traverse
 Single leaf door with transom

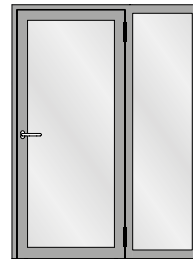

Einflügelige Türe mit festem Seitenteil
 Porte à un vantail avec partie latérale fixe
 Single leaf door with fixed side light

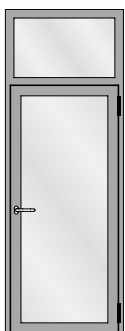

Einflügelige Türe mit festem Oberlicht
 Porte à un vantail avec imposte fixe
 Single leaf door with fixed top light

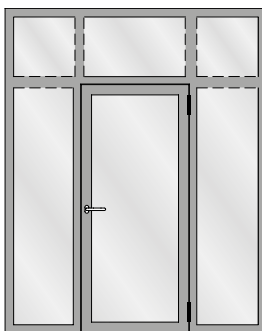

Einflügelige Türe mit zwei festen Seitenteilen
 und festem Oberlicht
 Porte à un vantail avec deux parties latérale fixe
 et imposte fixe
 Single leaf door with two fixed side light and
 fixed top light

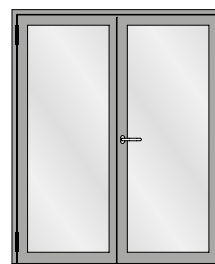

Zweiflügelige Türe
 Porte à deux vantaux
 Double leaf door



Zweiflügelige Türe mit zwei festen Seitenteilen
 Porte à deux vantaux avec deux parties
 latérales fixes
 Double leaf door with two fixed side lights

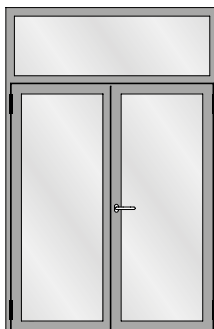

Zweiflügelige Türe mit festem Oberlicht
 Porte à deux vantaux avec imposte fixe
 Double leaf door with fixed top light

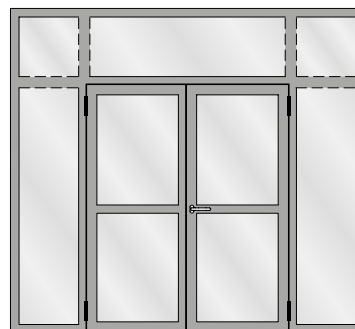

Zweiflügelige Türe mit zwei festen Seitenteilen
 und festen Oberlichtern
 Porte à deux vantaux avec deux parties latérales
 fixes et impostes fixes
 Double leaf door with two fixed side lights and
 fixed top lights

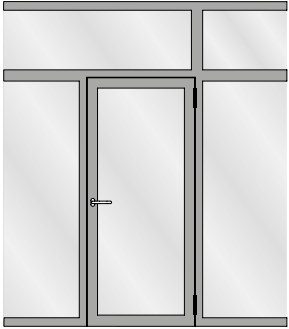

Festverglasung mit einflügeliger Türe
Vitrage fixe avec porte à un vantail
Fixed glazing with single leaf door

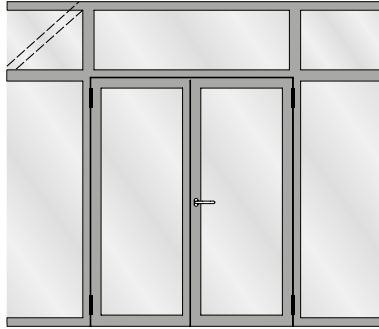

Festverglasung mit zweiflügeliger Türe
Vitrage fixe avec porte à deux vantaux
Fixed glazing with double leaf door

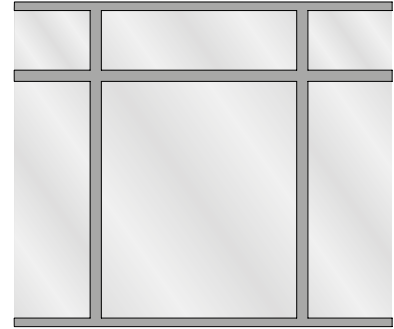

Festverglasung
Vitrage fixe
Fixed glazing

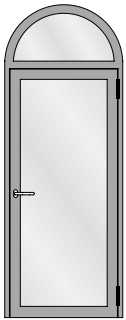

Einflügelige Türe mit Rundbogen-Oberlicht
Porte à un vantail avec imposte demi-ronde
Single leaf door with round arched top light

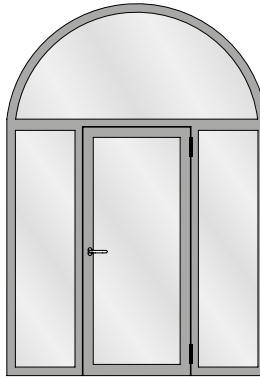

Einflügelige Türe mit zwei festen Seitenteilen
und Rundbogen-Oberlicht
Porte à un vantail avec deux parties latérales
fixes et imposte demi-ronde
Single leaf door with two fixed side lights and
round arched top light

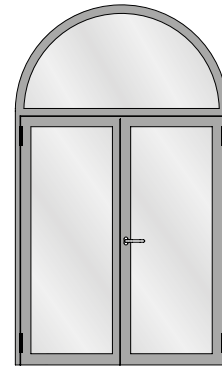

Zweiflügelige Türe mit Rundbogen-Oberlicht
Porte à deux vantaux avec imposte demi-ronde
Double leaf door with round arched top light

**Für Festverglasungen gelten
nationale Zulassungen.**

**Les homologations nationales
s'appliquent aux vitrages fixes.**

**National approvals apply to fixed
glazing.**

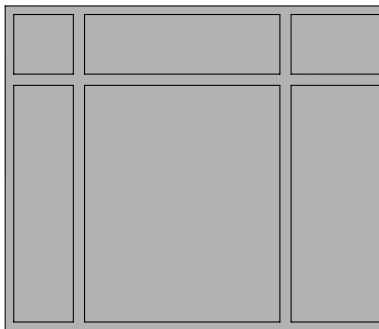
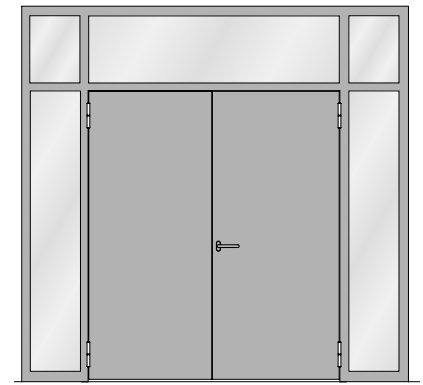
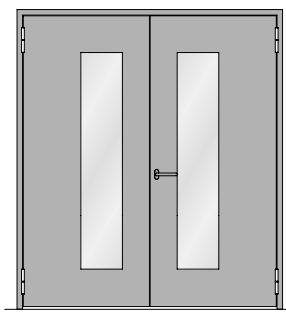
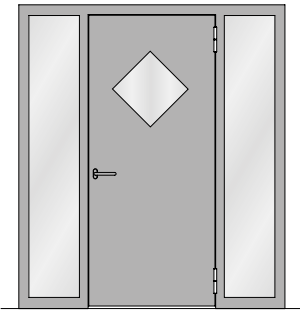
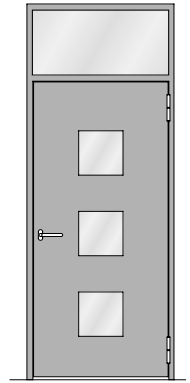
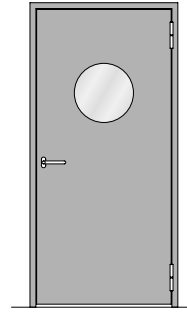
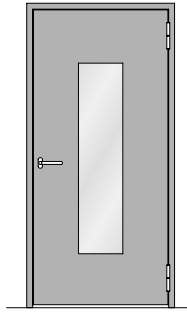
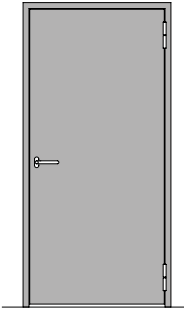

Für Festverglasungen gelten nationale Zulassungen.

Les homologations nationales s'appliquent aux vitrages fixes.

National approvals apply to fixed glazing.

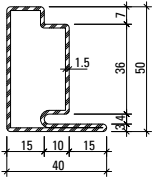

30.006
30.006 Z
 30.006.01

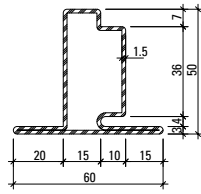

30.106
30.106 Z

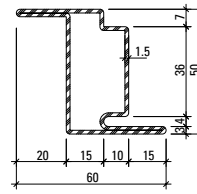

30.406
30.406 Z

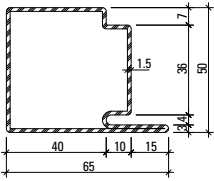

30.007
30.007 Z
 30.007.01

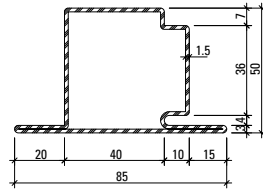

30.107
30.107 Z
 30.107.01

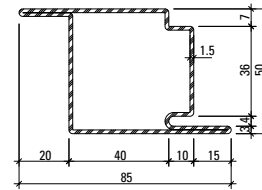

30.407
30.407 Z
 30.407.01

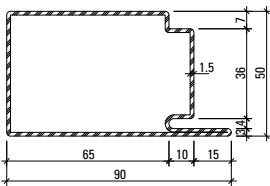

30.008
30.008 Z

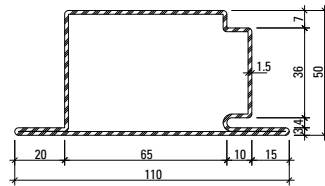

30.108
30.108 Z

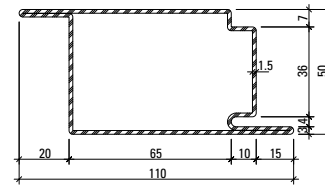

30.408
30.408 Z

Gewichte für die Edelstahl-Profile siehe Seite 15
 Poids pour profilés en acier Inox voir page 15
 Weights for stainless steel profiles see page 15

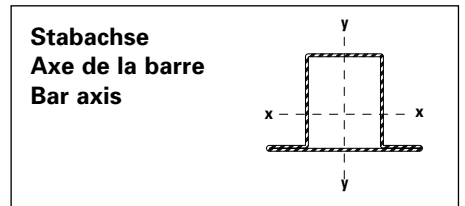

Profil-Nr.	G kg/m	F cm ²	I _x cm ⁴	W _x cm ³	I _y cm ⁴	W _y cm ³	U m ² /m
30.006	2,329	2,97	9,17	2,94	3,93	1,61	0,190
30.106	2,662	3,39	10,23	3,00	7,09	2,27	0,231
30.406	2,662	3,39	13,02	5,01	7,09	2,27	0,231
30.007	2,790	3,55	13,38	4,49	15,32	4,37	0,242
30.107	3,251	4,14	15,15	4,67	23,50	5,31	0,281

Profil-Nr.	G kg/m	F cm ²	I _x cm ⁴	W _x cm ³	I _y cm ⁴	W _y cm ³	U m ² /m
30.407	3,251	4,14	17,44	6,76	23,50	5,31	0,281
30.008	3,585	4,57	18,94	6,53	40,09	8,61	0,291
30.108	4,079	5,20	21,05	6,72	55,99	9,82	0,330
30.408	4,079	5,20	23,10	8,98	55,99	9,82	0,330

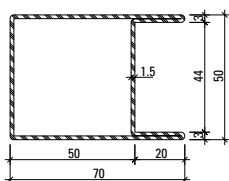

04.568
04.568 Z

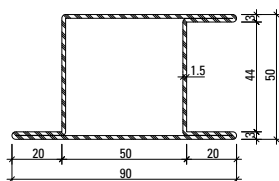

05.568
05.568 Z
05.568.01

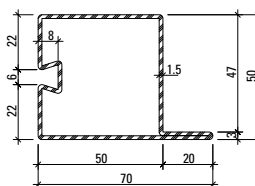

32.388
32.388 Z

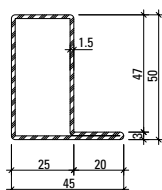

01.534
01.534 Z
01.534.01

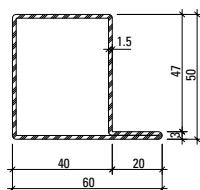

01.564
01.564 Z
01.564.01

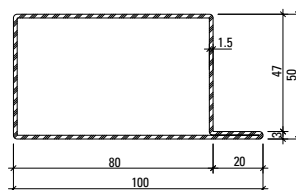

01.592
01.592 Z

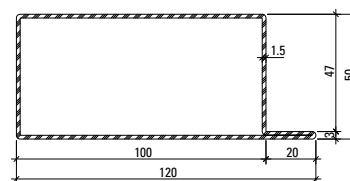

01.596

Gewichte für die Edelstahl-Profile
 siehe Seite 15

Poids pour profilés en acier Inox
 voir page 15

Weights for stainless steel profiles
 see page 15

Oberfläche/Werkstoff

Artikel-Nr.

ohne Zusatz = blank

mit Z = bandverzinkter Stahl

Werkstoff 1.4404 (AISI 316L)

mit 01 = blank

mit 03 = geschliffen, Korn 220-240

Edelstahl geschliffen auf Anfrage

Surface/Matériau

No. d'article

sans supplément = brut

avec Z = bande d'acier zinguée

Matériau 1.4404 (AISI 316L)

avec 01 = brut

avec 03 = polies, grain 220-240

Acier Inox polie sur demande

Surface/Material

Part no.

without addition = bright

with Z = strip galvanised steel

Material 1.4404 (AISI 316L)

with 01 = bright

with 03 = polished, grain 220-240

Stainless steel polished on request

Profil-Nr.	G kg/m	F cm ²	I _x cm ⁴	W _x cm ³	I _y cm ⁴	W _y cm ³	U m ² /m
01.534	2,124	2,71	9,30	3,09	4,77	1,73	0,185
01.564	2,479	3,16	12,05	4,10	11,13	3,23	0,215
01.592	3,429	4,37	19,35	6,87	46,90	8,80	0,296
01.596	3,900	4,97	22,93	8,25	77,23	12,28	0,336

Profil-Nr.	G kg/m	F cm ²	I _x cm ⁴	W _x cm ³	I _y cm ⁴	W _y cm ³	U m ² /m
04.568	3,186	4,06	17,76	7,11	21,77	6,20	0,275
05.568	3,613	4,64	20,55	7,34	32,32	6,54	0,314
32.388	2,929	3,73	13,98	4,86	18,46	4,54	0,253

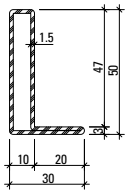

01.531
01.531 Z

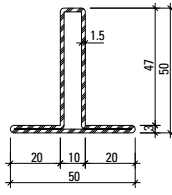

02.531
02.531 Z

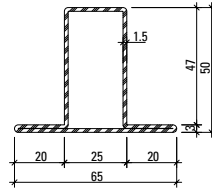

02.534
02.534 Z
 02.534.01

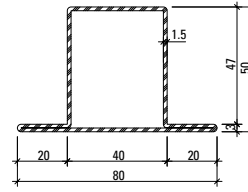

02.564
02.564 Z
 02.564.01

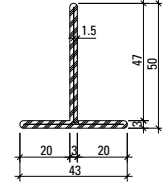

400.023
400.023 Z

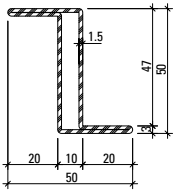

03.531
03.531 Z

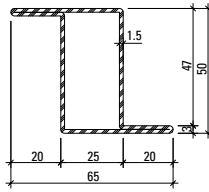

03.534
03.534 Z

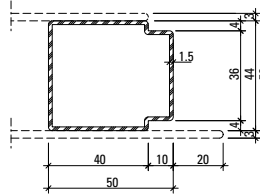

81.009 Z

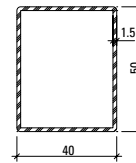

400.048
400.048 Z

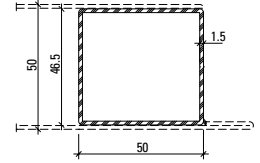

400.049 Z

Artikelbibliothek
 Bibliothèque des articles
 Article library

DXF **DWG**

Stabachse
Axe de la barre
Bar axis

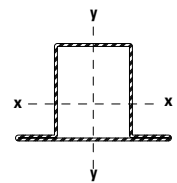

Profil-Nr.	G kg/m	F cm ²	I _x cm ⁴	W _x cm ³	I _y cm ⁴	W _y cm ³	U m ² /m
01.531	1,881	2,396	6,87	2,21	1,51	0,71	0,155
02.531	2,371	3,02	8,36	2,41	3,46	1,38	0,194
02.534	2,587	3,30	10,94	3,27	8,55	2,63	0,224
03.531	2,244	2,86	10,71	4,28	3,26	1,30	0,195
02.564	2,941	3,75	13,87	4,28	17,56	4,39	0,254
03.534	2,587	3,30	13,28	5,31	8,55	2,63	0,224

Profil-Nr.	G kg/m	F cm ²	I _x cm ⁴	W _x cm ³	I _y cm ⁴	W _y cm ³	U m ² /m
81.009	2,093	2,67	7,79	3,54	9,63	3,76	0,182
400.023	2,657	2,09	6,64	1,88	1,91	0,89	0,195
400.048	2,024	2,58	9,46	3,78	6,70	3,35	0,177
400.049	2,177	2,77	10,61	4,24	9,49	4,08	0,190

Profilübersicht
Sommaire des profilés
Summary of profiles

Jansen-Economy 50 RS
Jansen-Economy 50 RS
Jansen-Economy 50 RS

Oberfläche/Werkstoff

Artikel-Nr.

ohne Zusatz = blank

mit Z = bandverzinkter Stahl

Werkstoff 1.4404 (AISI 316L)

mit 01 = blank

mit 03 = geschliffen, Korn 220-240

Edelstahl geschliffen auf Anfrage

Surface/Matériau

No. d'article

sans supplément = brut

avec Z = bande d'acier zinguée

Matériau 1.4404 (AISI 316L)

avec 01 = brut

avec 03 = polies, grain 220-240

Acier Inox polie sur demande

Surface/Material

Part no.

without addition = bright

with Z = strip galvanised steel

Material 1.4404 (AISI 316L)

with 01 = bright

with 03 = polished, grain 220-240

Stainless steel polished on request

Gewichte für Edelstahl-Profile

.01 = Werkstoff 1.4404 (AISI 316L)

30.006.01 = 2,232 kg/m

30.007.01 = 2,832 kg/m

30.107.01 = 3,288 kg/m

30.407.01 = 3,288 kg/m

01.534.01 = 2,153 kg/m

02.534.01 = 2,622 kg/m

01.564.01 = 2,513 kg/m

02.564.01 = 2,975 kg/m

05.568.01 = 3,672 kg/m

Poids pour profilés en acier Inox

.01 = matériau 1.4404 (AISI 316L)

Weights for stainless steel profiles

.01 = material 1.4404 (AISI 316L)

Bogentüren
Portes cintrées
Arched doors

Jansen-Economy 50 RS
 Jansen-Economy 50 RS
 Jansen-Economy 50 RS

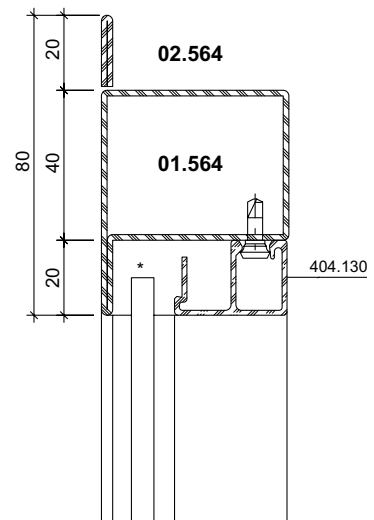
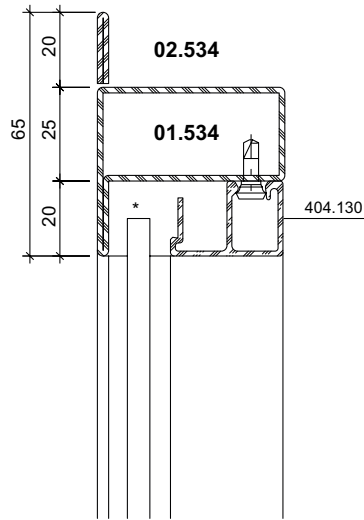
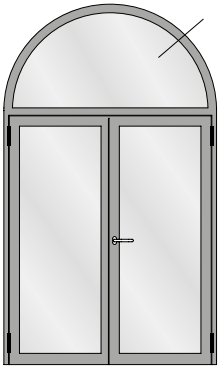

* Füllelemente mit rauchdichtem dauerelastischem Dichtstoff (z.B. 450.092) vollständig in den Glasfalzgrund einkleben.

* Coller entièrement les éléments de remplissage avec produit d'étanchéité à l'élasticité permanente (p.ex. 450.092) dans la feuillure en verre.

* Infill panels with smoke-tight, permanently flexible sealant (e.g. 450.092) fully glued into the glazing rebate platform.

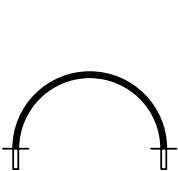

Halbrundbogen
 Arc semi-circulaire
 Semi-circular arch

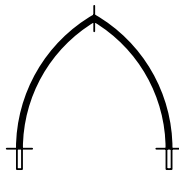

Spitzbogen
 Arc en ogive
 Gothic arch



Stichbogen
 Arc bombé
 Segmented arch



Korbbogen
 Anse de panier
 Oval arch

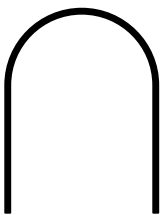

Halbrundbogen mit Schenkel
 Arc surhaussé prolongée
 Semi-circular arch with side extension

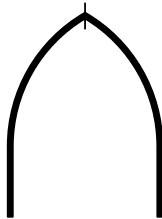

Spitzbogen mit Schenkel
 Arc en ogive prolongée
 Gothic arch with side extension

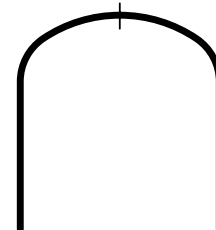



Korbbogen mit Schenkel
 Anse de panier prolongée
 Oval arch with side extension

Bogentüren
Portes cintrées
Arched doors

Jansen-Economy 50 RS
 Jansen-Economy 50 RS
 Jansen-Economy 50 RS

Profil Profilé Profile	Min. Radius Rayon min. Min. radius R	
------------------------------	---	--

	blank brut bright	verzinkt zinguée galvanised
	mm	mm
01.531	350	
01.534	400	400
01.564	650	650
01.592	2000	

		
02.531	400	400
02.534	600	800
02.564	700	1050
400.023	800	800

		
03.531	600	
03.534	600	800

	
04.568	850

		
05.568	850	1250

		
400.048	800	800
400.049	950	950

Stahl-Glasleisten Parcloses en acier Steel glazing beads	Min. Radius Rayon min. Min. radius R
--	---

	
402.112 Z	500 mm
402.115 Z	500 mm
402.120 Z	600 mm
402.125 Z	750 mm
402.130 Z	1000 mm
402.135 Z	1500 mm

Stahl-Glasleisten Parcloses en acier Steel glazing beads	Min. Radius Rayon min. Min. radius R
--	---

	
62.507 Z	300 mm
62.508 Z	300 mm
62.509 Z	300 mm

Aluminium-Glasleisten Parcloses en aluminium Aluminium glazing beads	Min. Radius Rayon min. Min. radius R
--	---

	
404.112	400 mm
404.115	400 mm
404.120	400 mm
404.125	450 mm
404.130	500 mm
404.135	600 mm

	
405.115	500 mm
405.120	500 mm
405.125	800 mm
405.130	1000 mm
406.903	500 mm
406.905	500 mm
406.907	500 mm
406.909	600 mm

Biegen von Edelstahl-Profilen auf Anfrage!

Die Radien-Angaben beziehen sich auf die langjährige Erfahrung und Fertigung im Hause Jansen.

Profilés acier Inox sur demande!

Les rayons indiqués se fondent sur la longue expérience et la fabrication au sein de la maison Jansen.

Stainless steel profiles on request!

The radii specifications are based on the many years of experience Jansen has in fabrication.

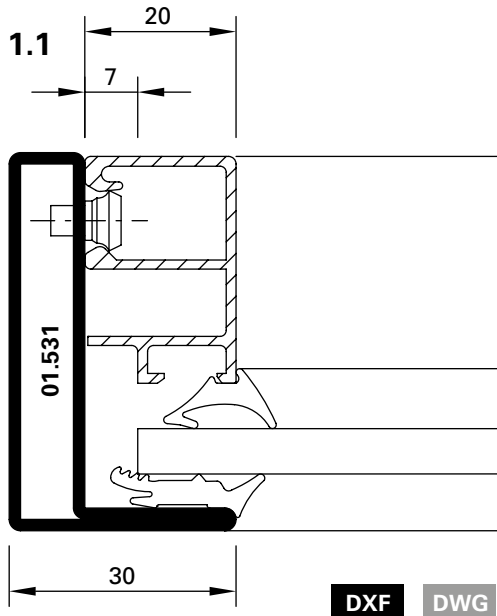
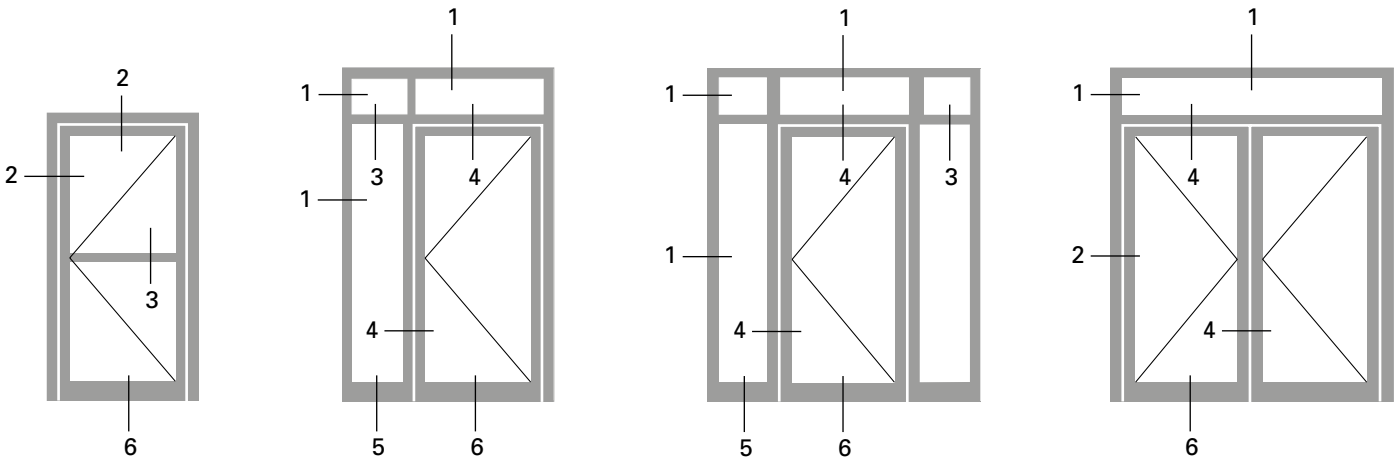

DXF DWG

41-0101-C-001

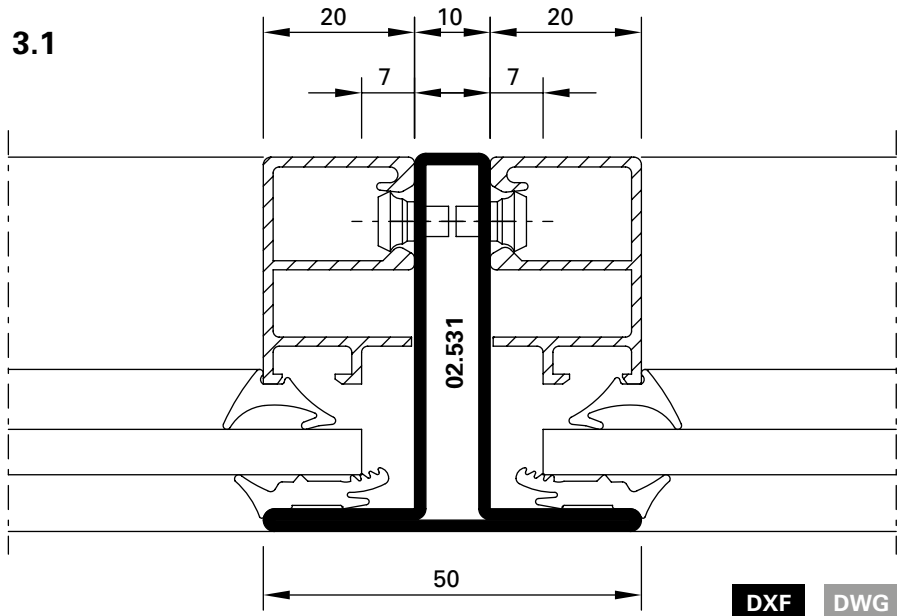

DXF DWG

41-0101-C-002

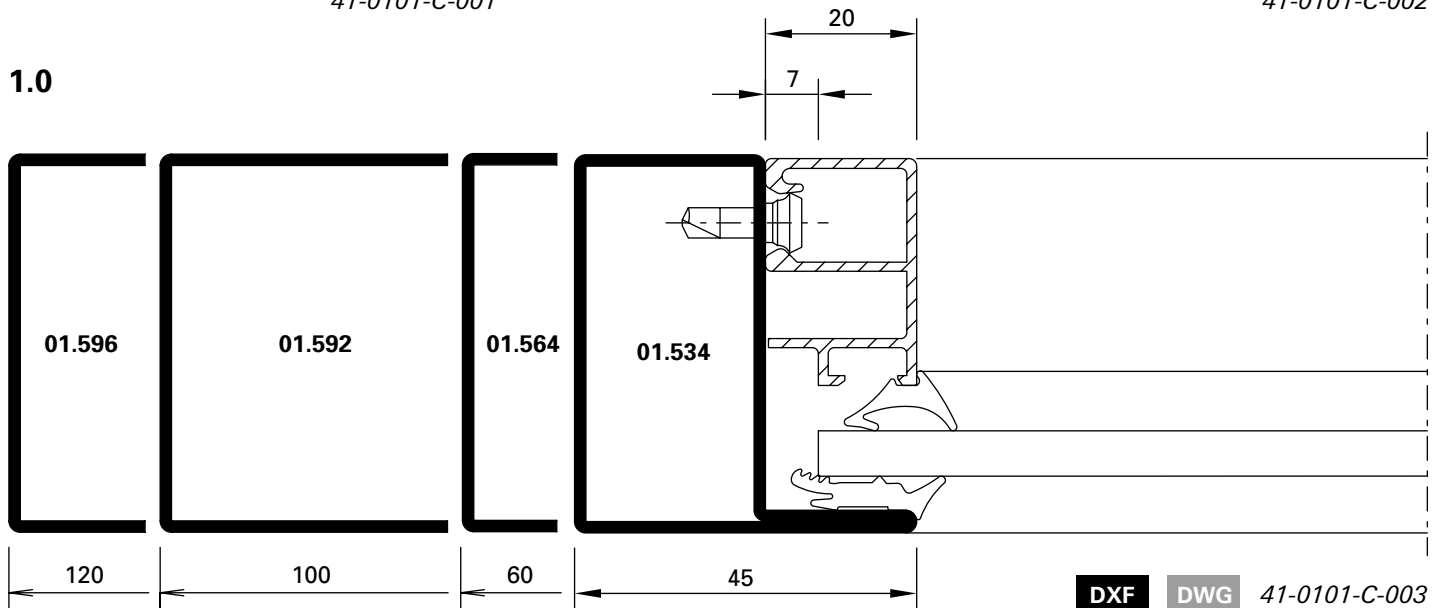

DXF DWG 41-0101-C-003

2.0

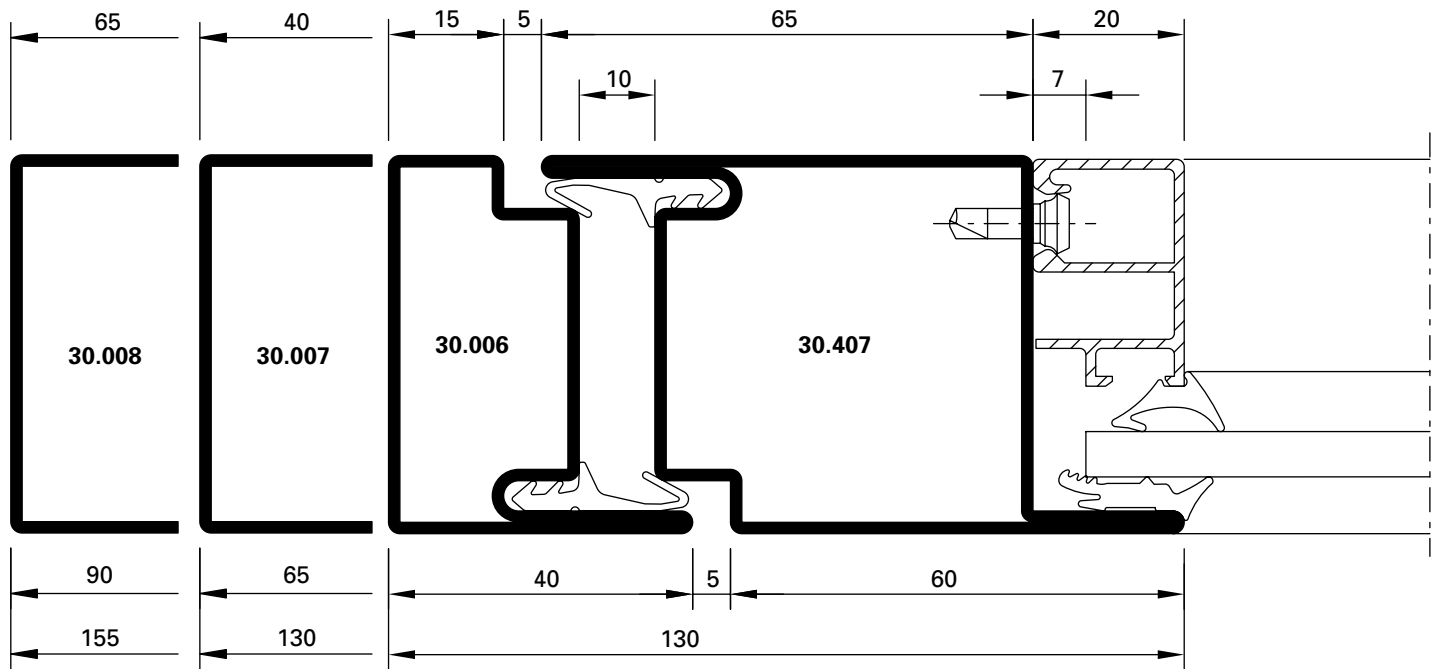

DXF **DWG** 41-0101-C-004

2.1

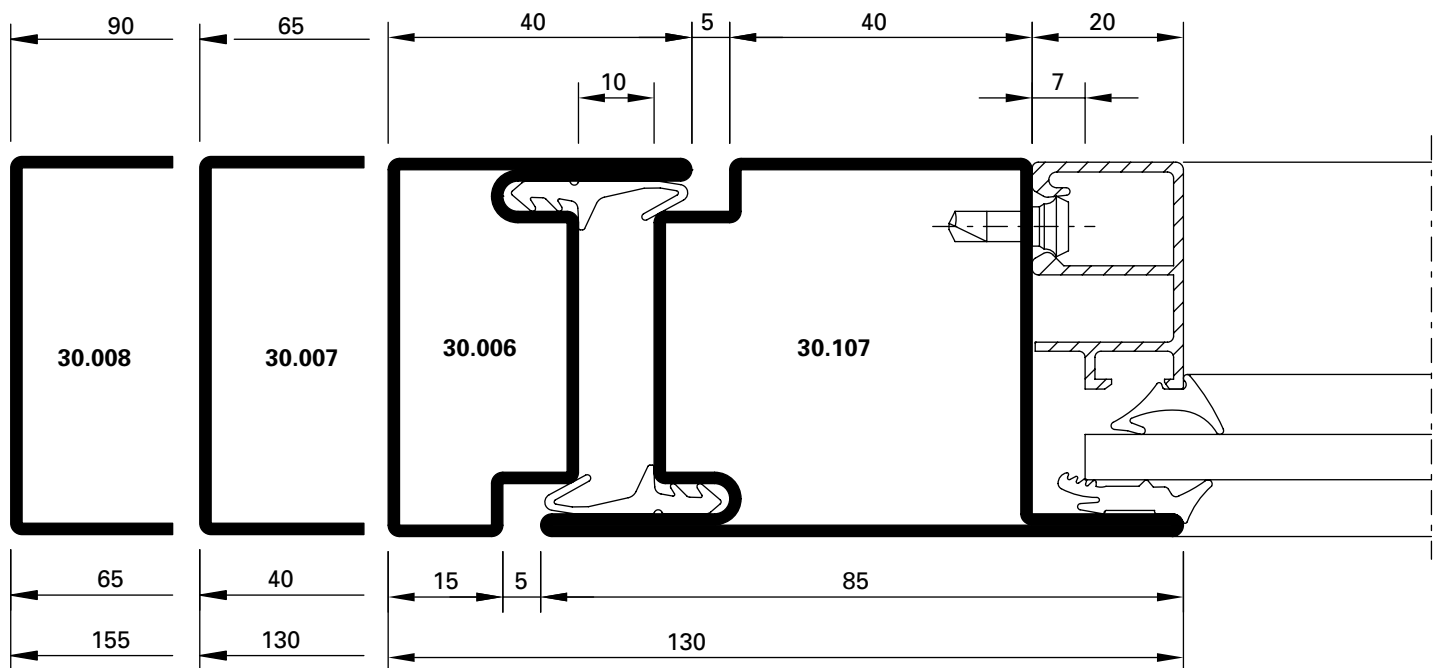

DXF **DWG** 41-0101-C-005

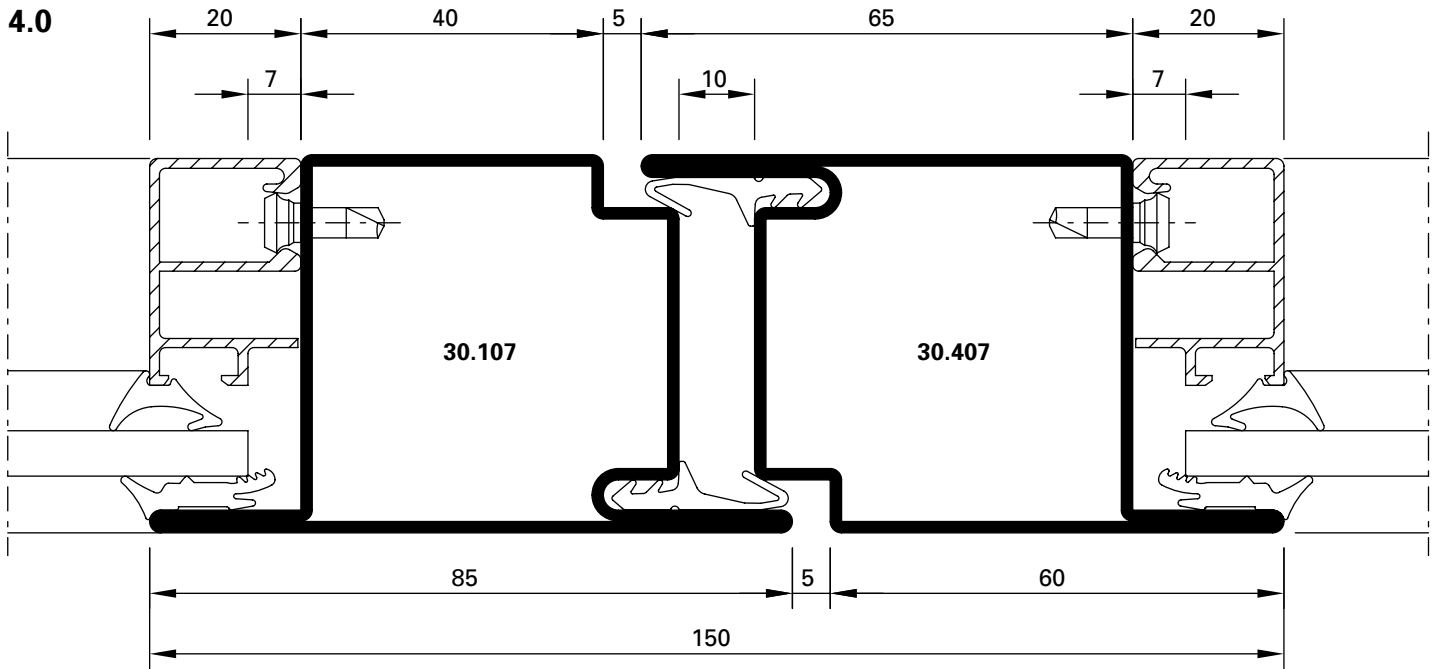

DXF DWG

41-0101-C-006

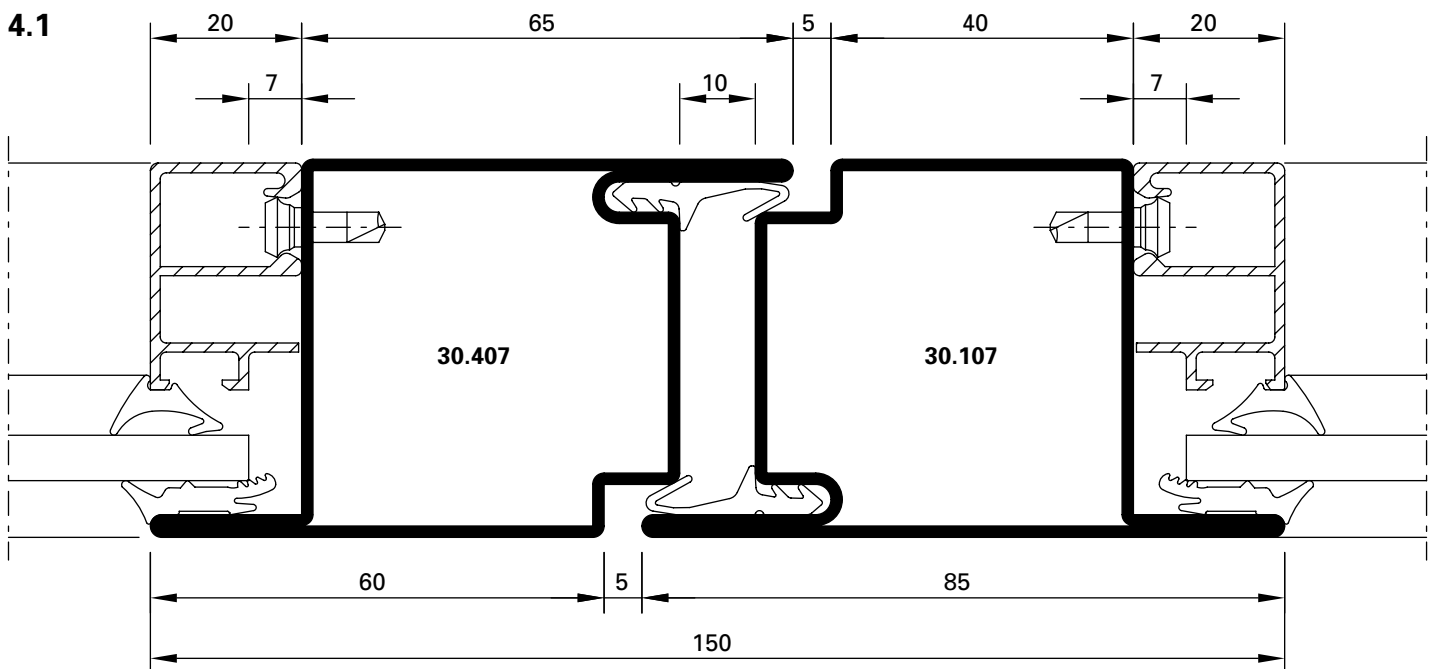

DXF DWG

41-0101-C-007

2.2

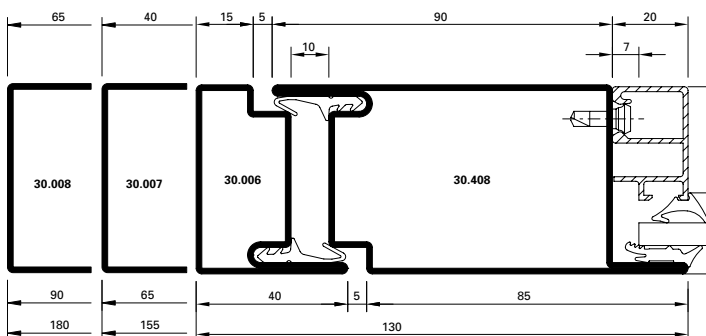

DXF **DWG** 41-0101-C-008

2.3

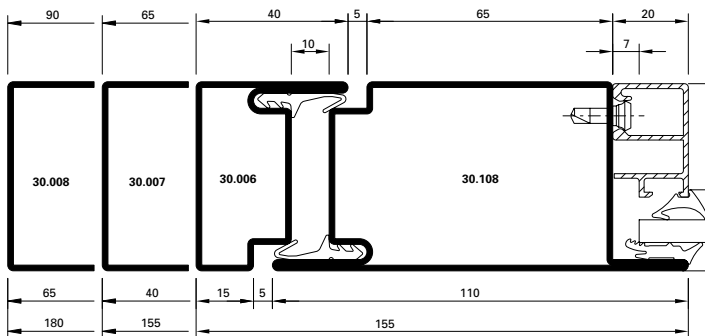

DXF **DWG** 41-0101-C-009

3.0

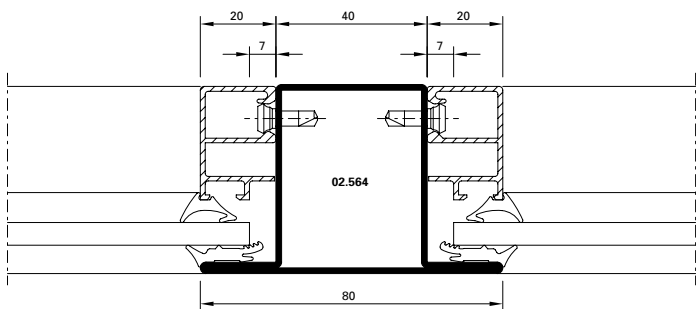

DXF **DWG** 41-0101-C-010

3.2

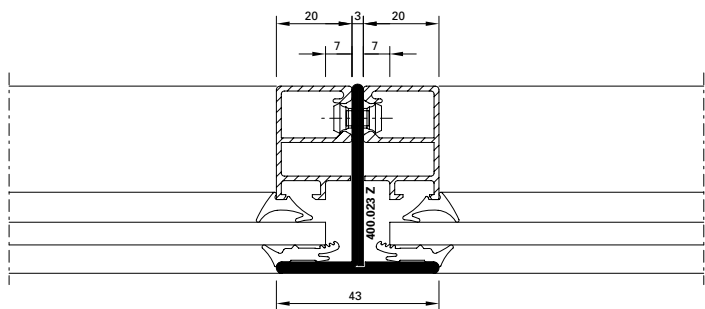

DXF **DWG** 41-0101-C-011

2.4

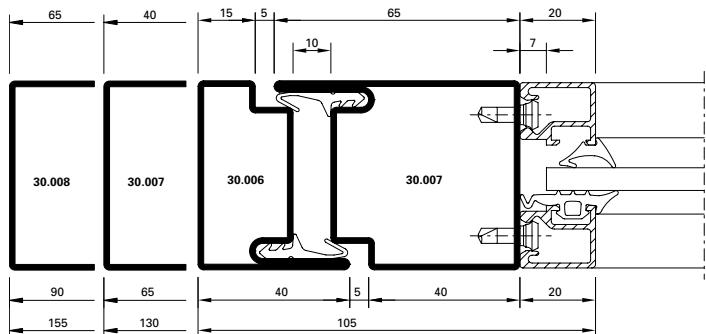

DXF **DWG** 41-0101-C-012

4.2

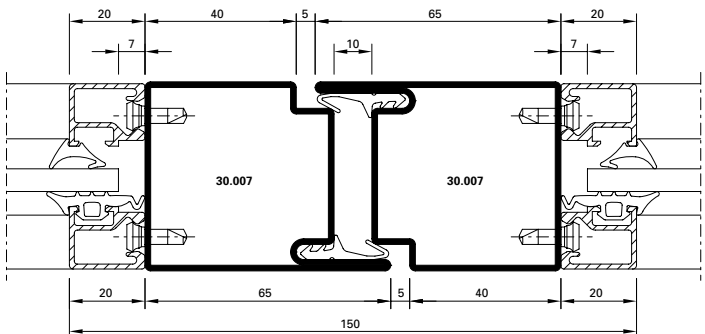

DXF **DWG** 41-0101-C-013

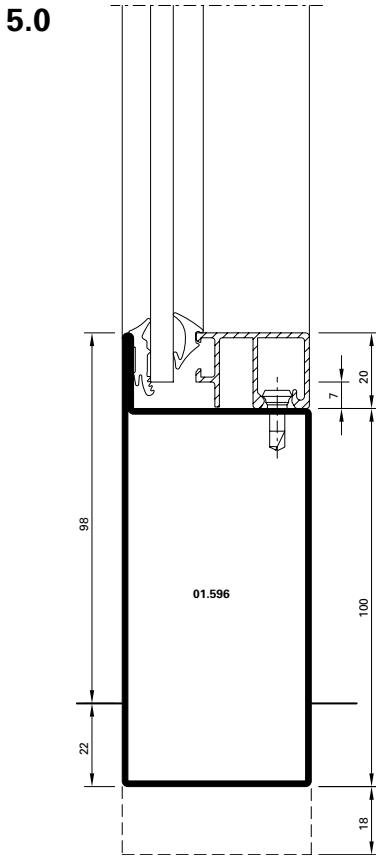

DXF DWG 41-0101-C-014

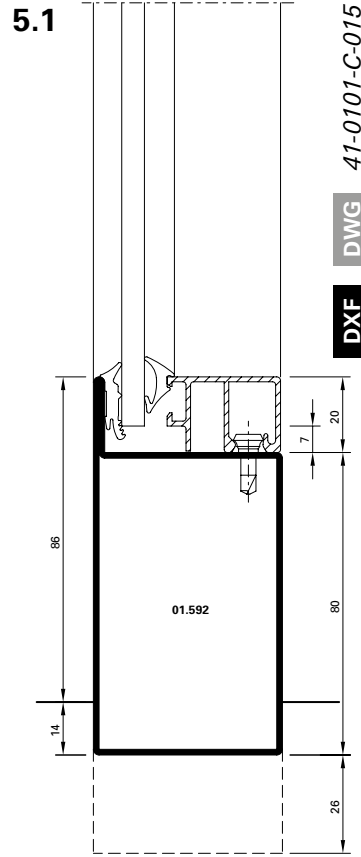

DXF DWG 41-0101-C-015

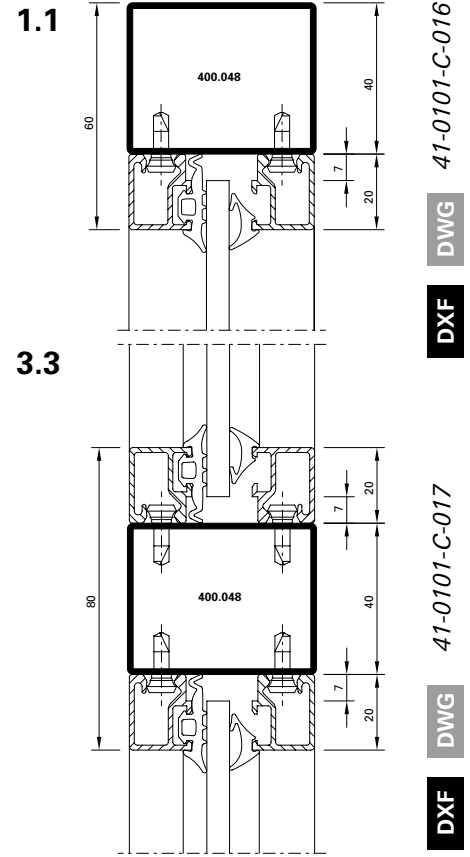

DXF DWG 41-0101-C-016

DXF DWG 41-0101-C-017

DXF DWG 41-0101-C-017

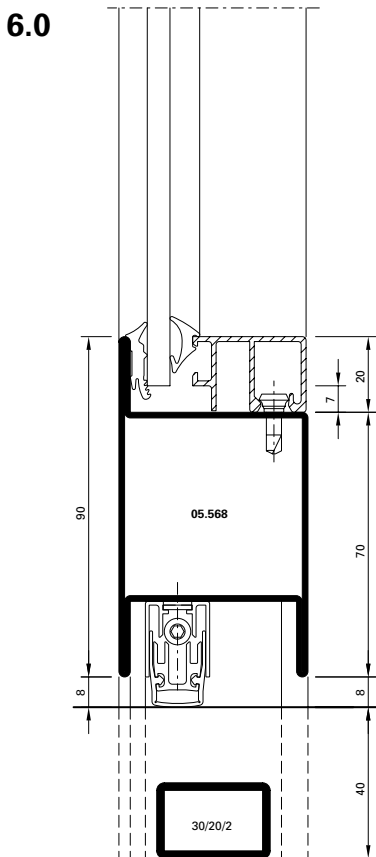

DXF DWG 41-0101-C-018

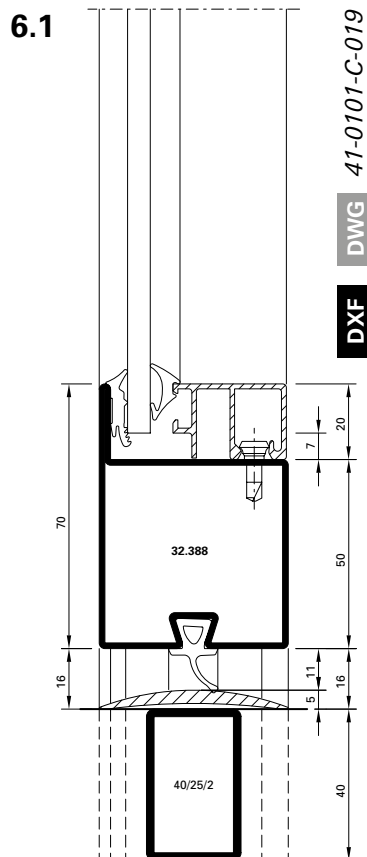

DXF DWG 41-0101-C-019

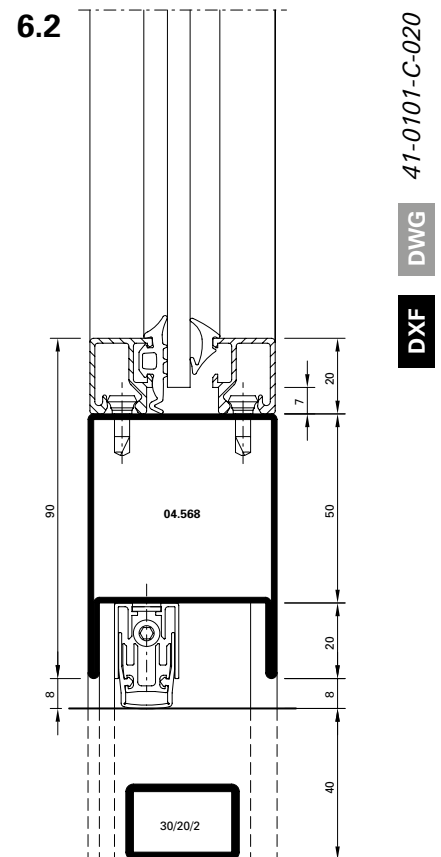

DXF DWG 41-0101-C-020

DXF DWG 41-0101-C-020

Glasleisten-Varianten im Massstab 1:2
Variantes de parcloses à l'échelle 1:2
Glazing bead options on scale 1:2

Jansen-Economy 50 RS
Jansen-Economy 50 RS
Jansen-Economy 50 RS

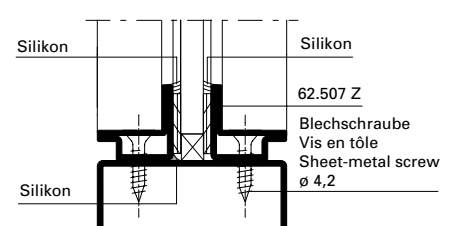
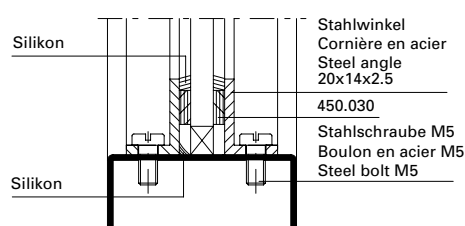
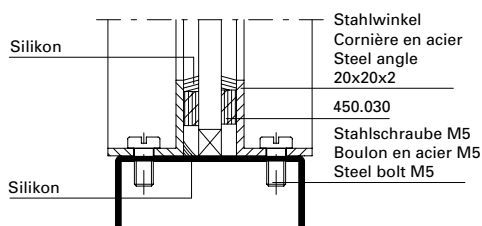
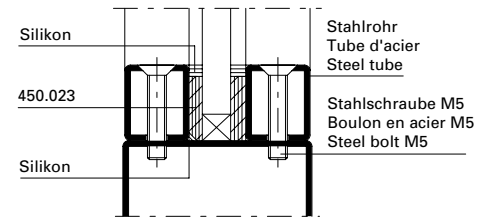
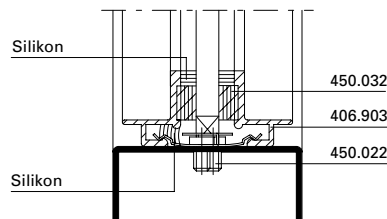
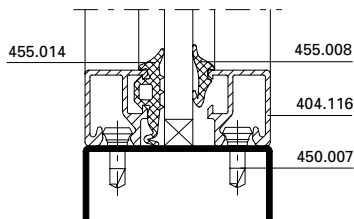
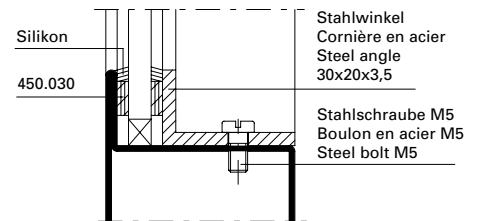
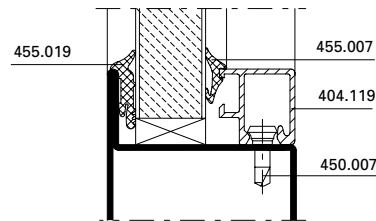
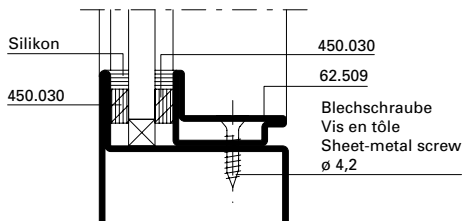
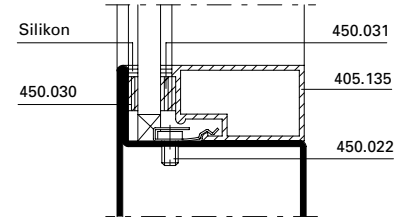
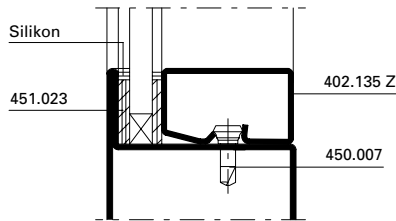
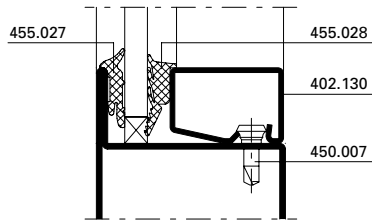
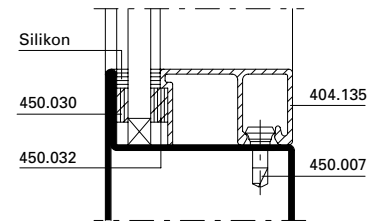
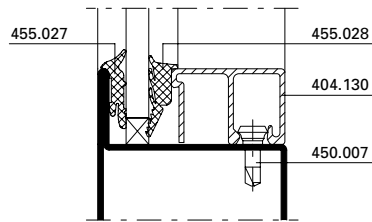
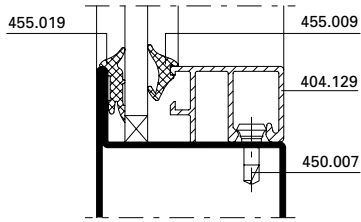

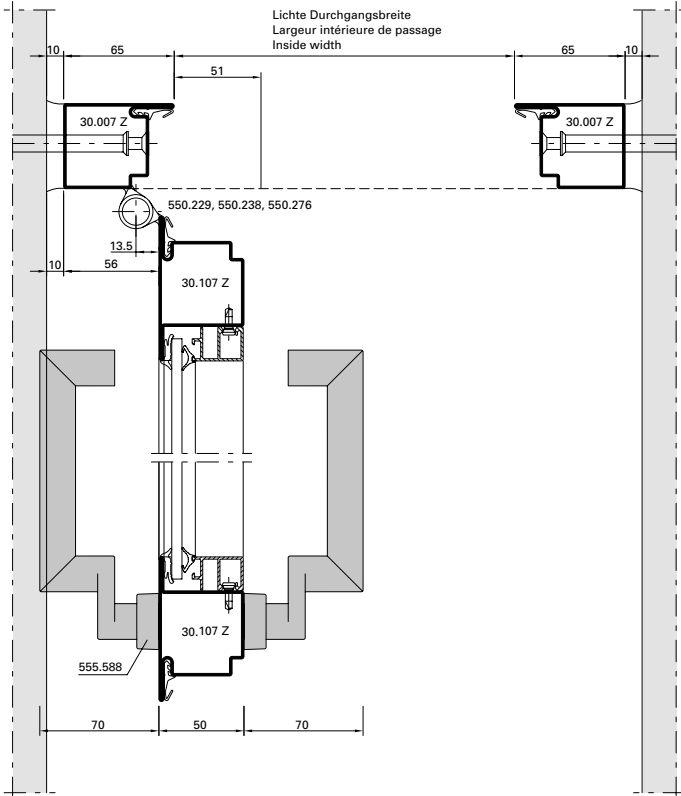

DXF **DWG** 41-0101-E-001

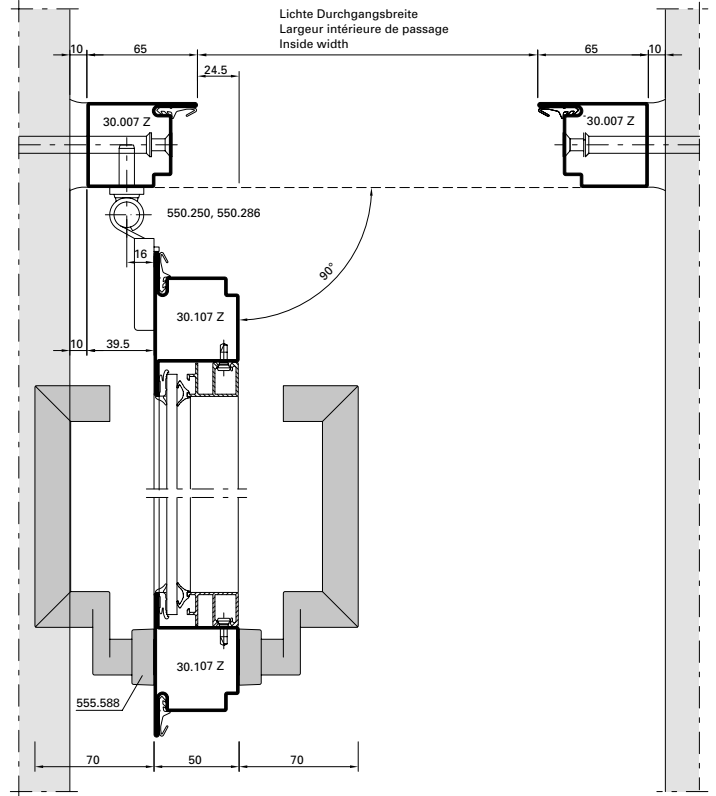

DXF **DWG** 41-0101-E-003

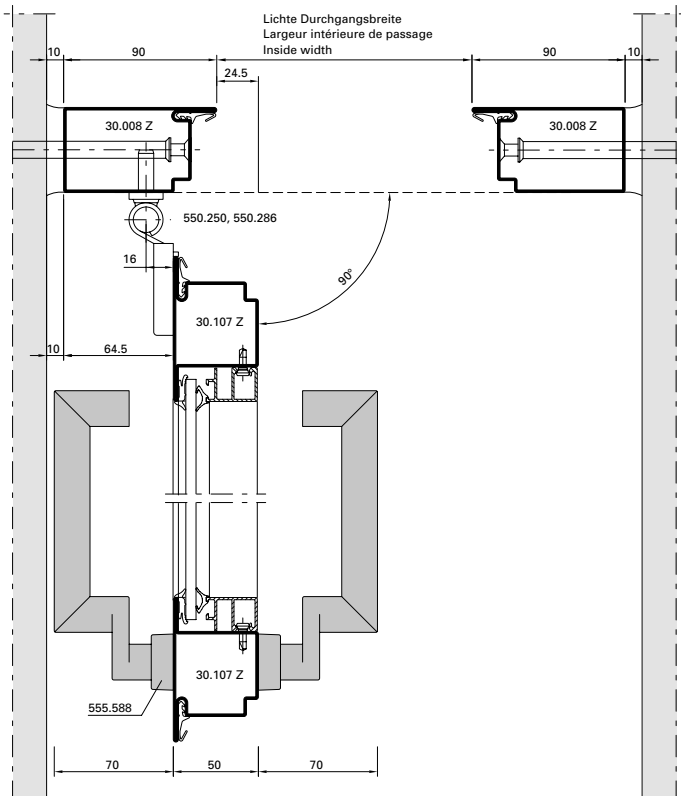

DXF **DWG** 41-0101-E-004

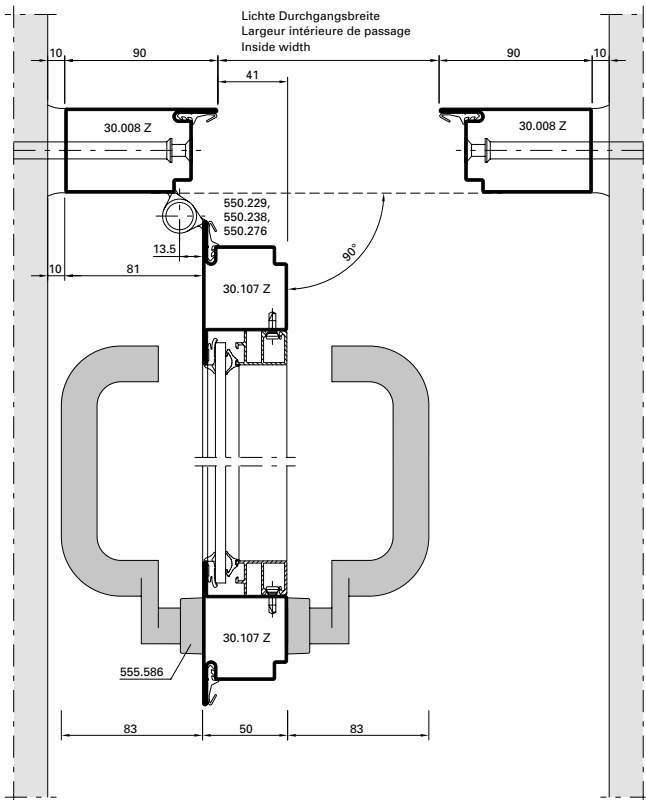

DXF **DWG** 41-0101-E-002

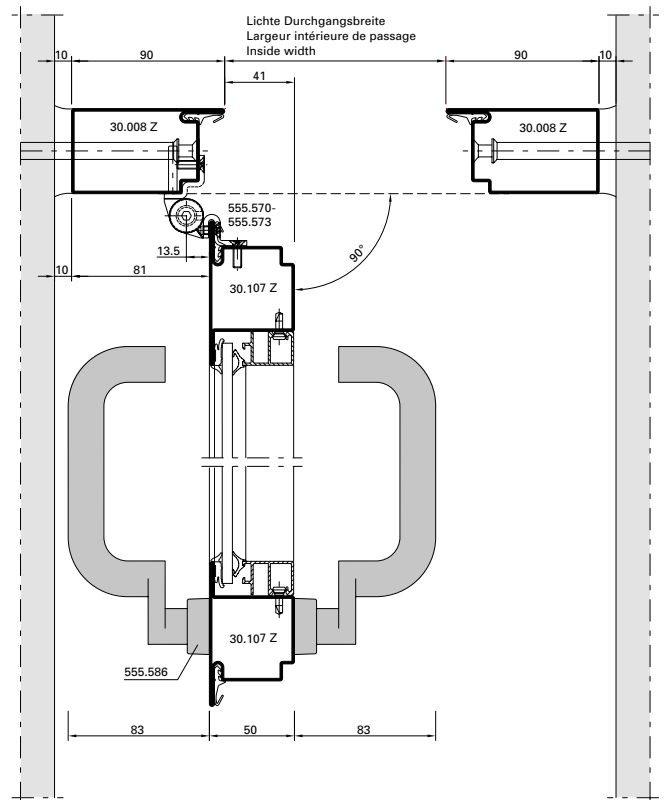

DXF **DWG** 41-0101-E-010

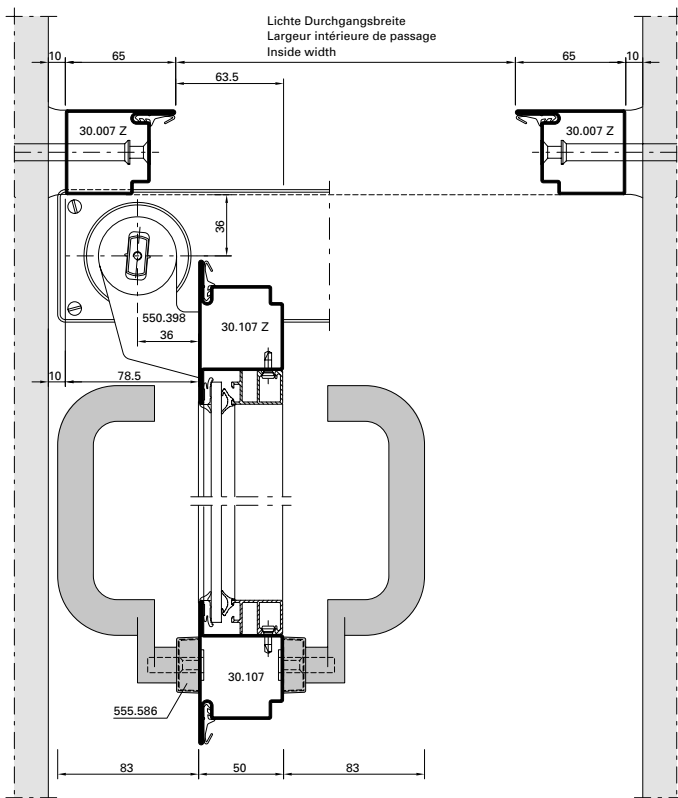

DXF **DWG** 41-0101-E-005

Anschlüsse am Bau im Masstab 1:2

Raccords au mur à l'échelle 1:2

Attachment to structure on scale 1:2

Jansen-Economy 50 RS

Jansen-Economy 50 RS

Jansen-Economy 50 RS

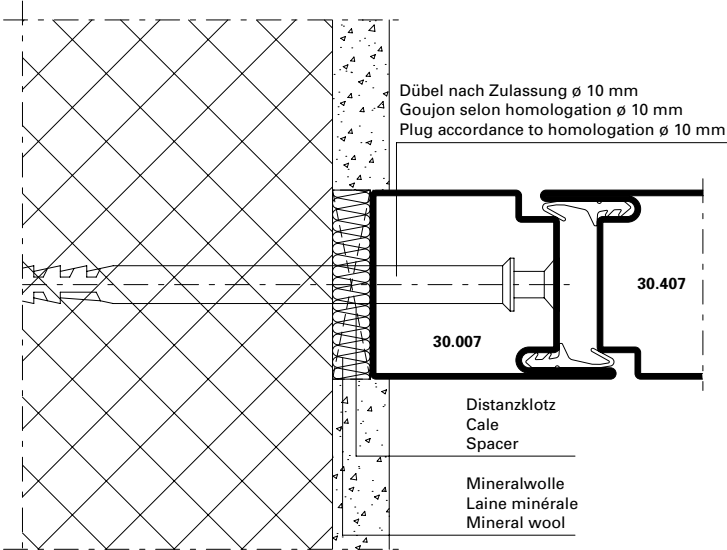

DXF DWG 41-0101-A-001

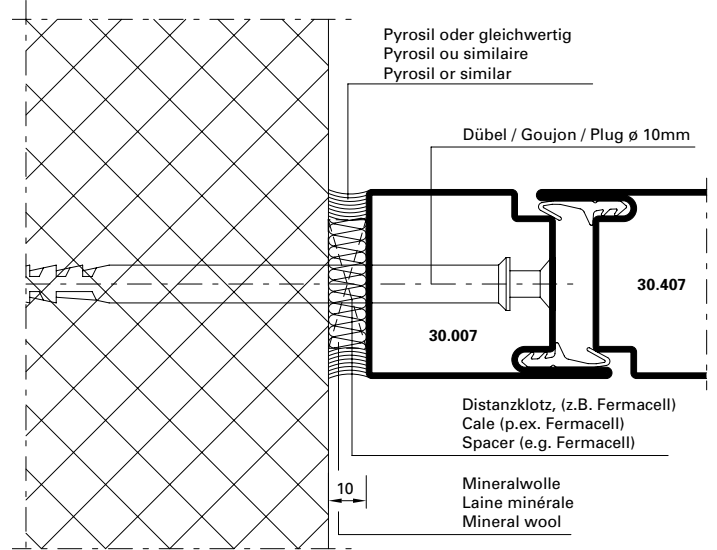

DXF DWG 41-0101-A-002

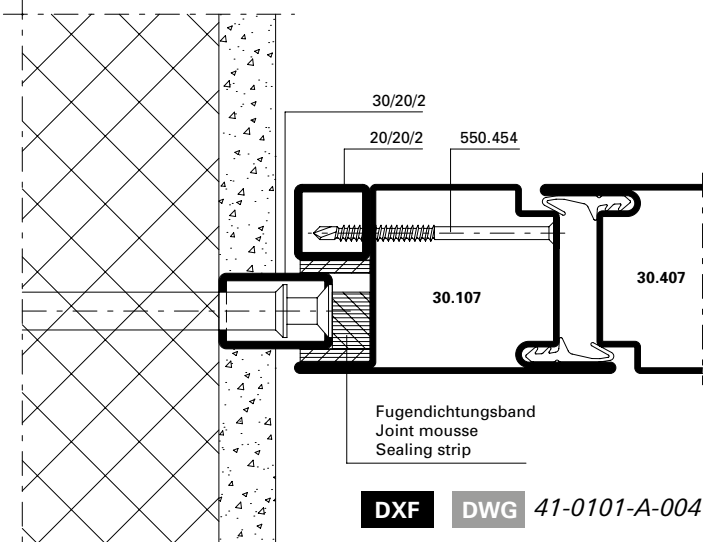

DXF DWG 41-0101-A-004

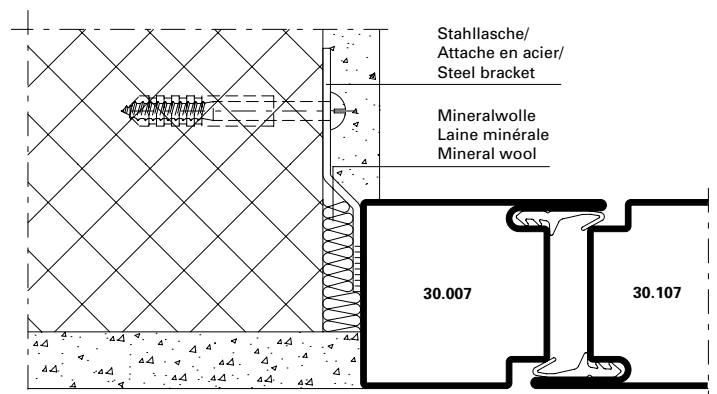

DXF DWG 41-0101-A-003

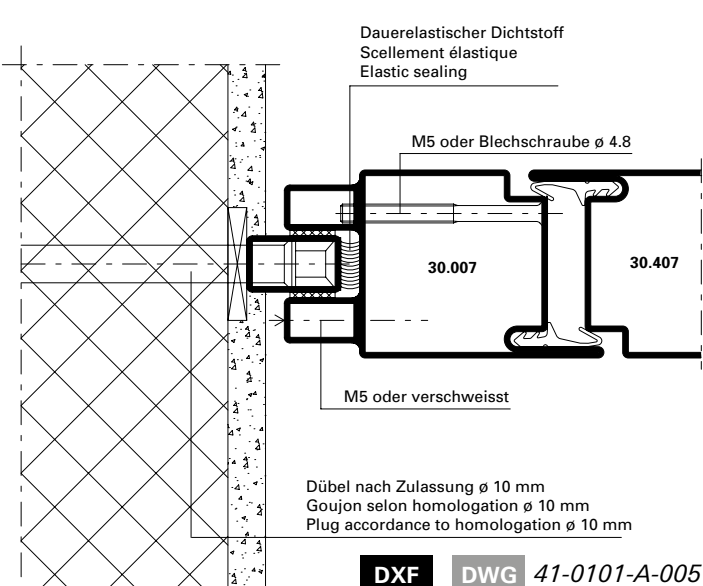

DXF DWG 41-0101-A-005

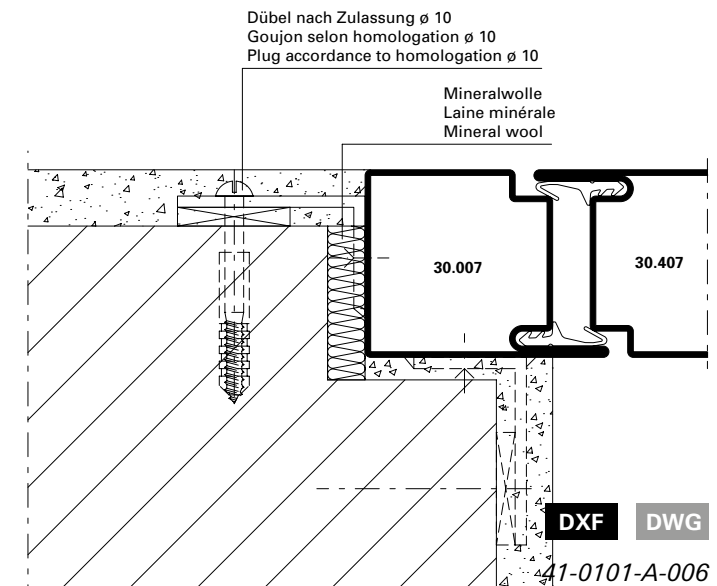

DXF DWG 41-0101-A-006

Anschlüsse am Bau im Masstab 1:2

Raccords au mur à l'échelle 1:2

Attachment to structure on scale 1:2

Jansen-Economy 50 RS

Jansen-Economy 50 RS

Jansen-Economy 50 RS

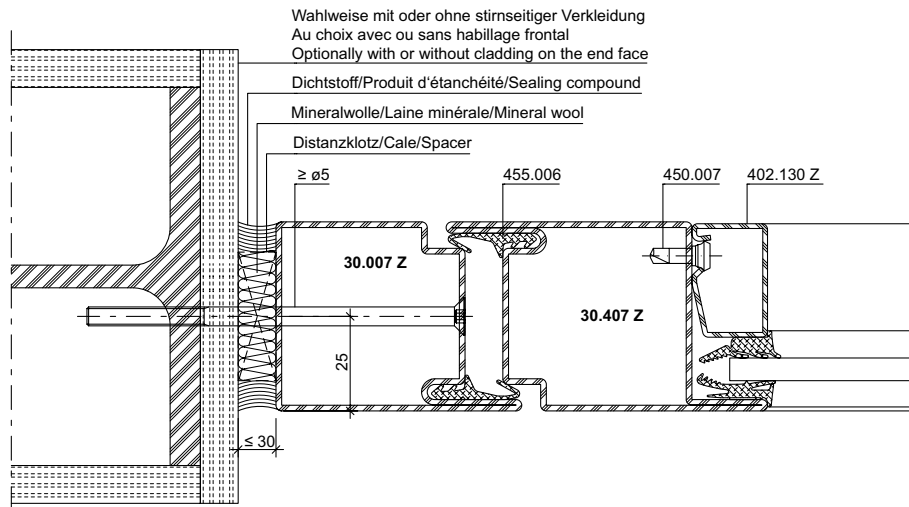

DXF

DWG

41-0101-A-007

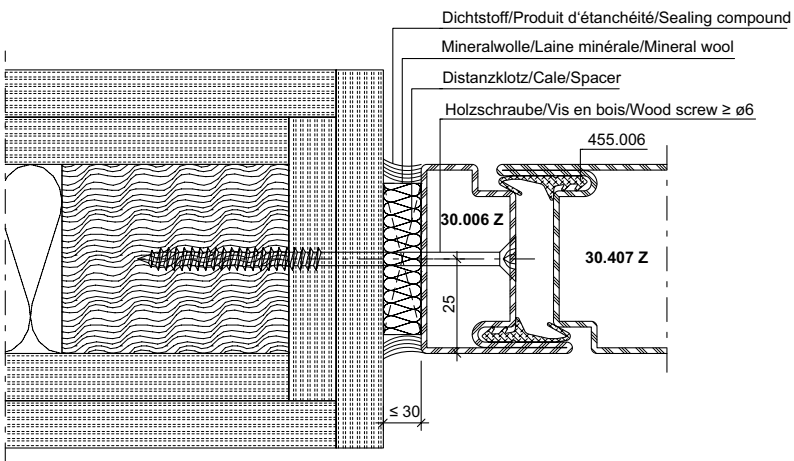

DXF

DWG

41-0101-A-008

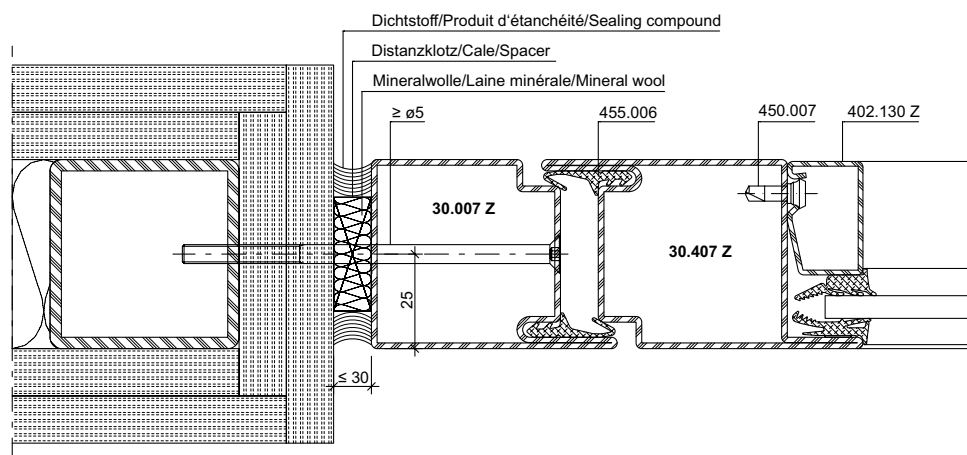

DXF

DWG

41-0101-A-009

Anschlüsse am Bau im Masstab 1:2

Raccords au mur à l'échelle 1:2

Attachment to structure on scale 1:2

Jansen-Economy 50 RS

Jansen-Economy 50 RS

Jansen-Economy 50 RS

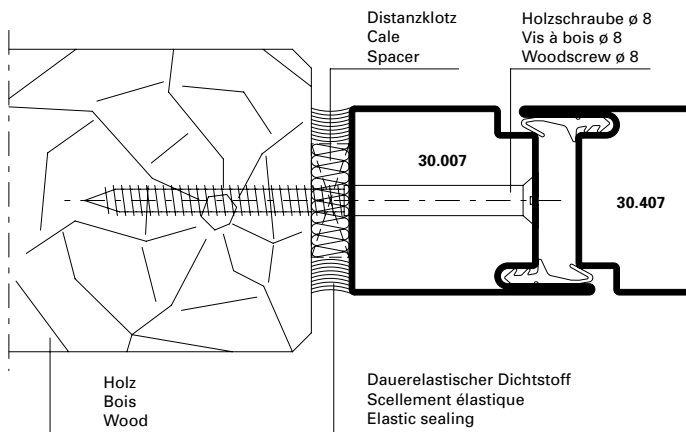

DXF DWG 41-0101-A-008

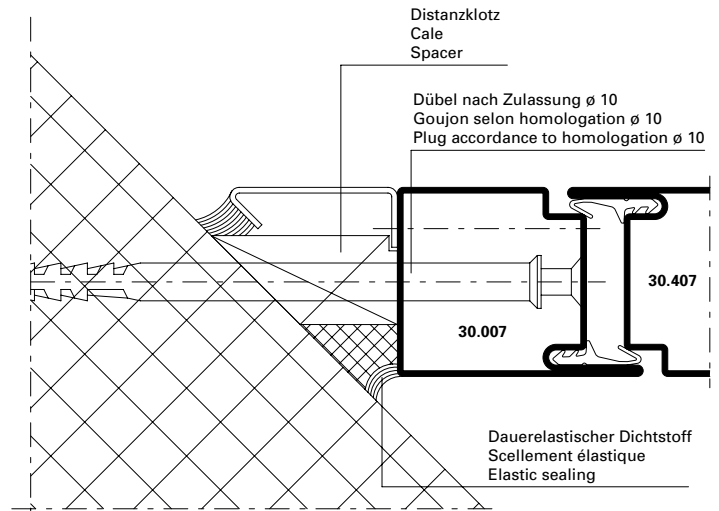

DXF DWG 41-0101-A-010

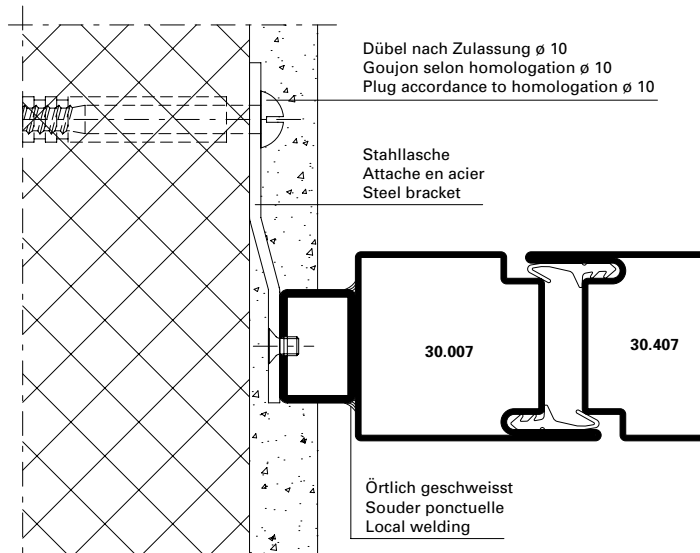

DXF DWG 41-0101-A-012

Anschlüsse am Bau im Masstab 1:2
Raccords au mur à l'échelle 1:2
Attachment to structure on scale 1:2

Jansen-Economy 50 RS
 Jansen-Economy 50 RS
 Jansen-Economy 50 RS

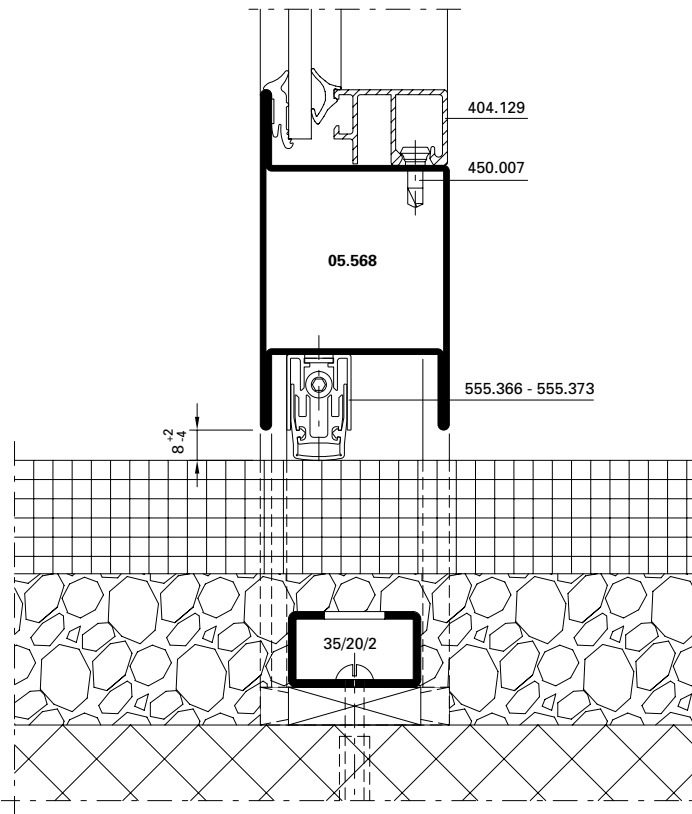

DXF DWG 41-0101-A-013

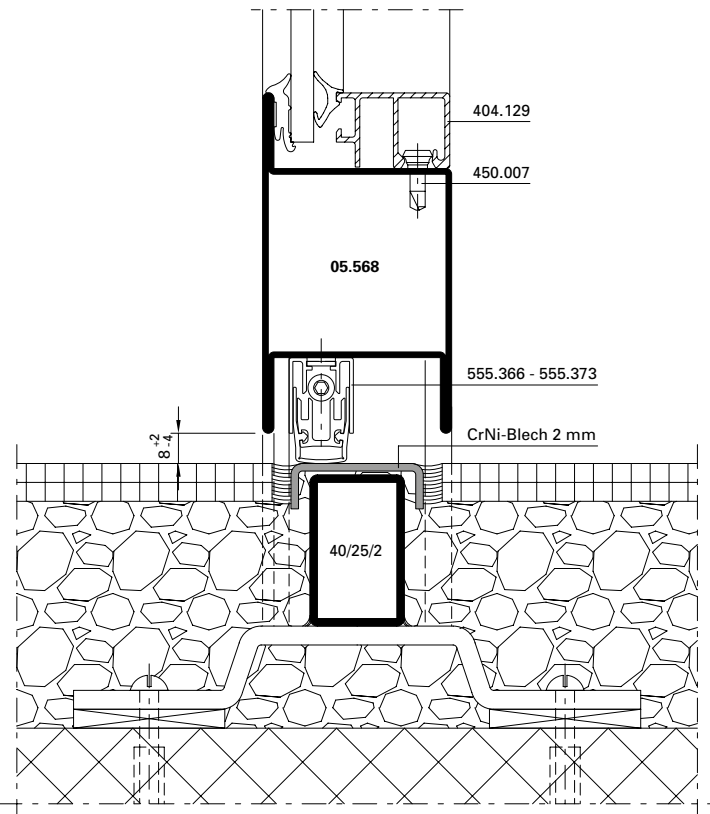

DXF DWG 41-0101-A-014

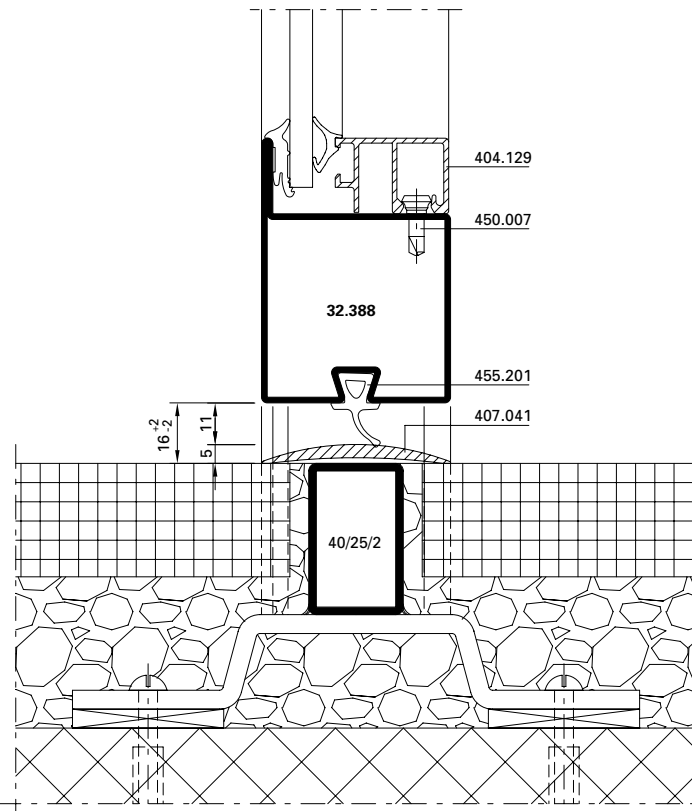

DXF DWG 41-0101-A-015

Bei Verwendung der Schwelldichtung 455.201 und Anschlagdichtung 455.006 muss der Standflügel von zweiflügeligen Türen nach unten verriegelt werden.



Dans le cas de l'utilisation du joint 455.201 et 455.006, le vantail semi-fixe des portes à deux vantaux devra être verrouillé aussi en bas.

When using gasket 455.201 and 455.006 on two leaf doors the fixed leaf must be locked towards the bottom.

Einflügelige Türen,
 auswärts öffnend,
 Flügelhöhe ≤ 2200 mm

Porte à un vantail,
 ouvrant vers l'extérieur,
 hauteur du vantail ≤ 2200 mm

Single leaf door,
 outward opening,
 leaf height ≤ 2200 mm

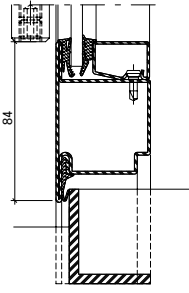
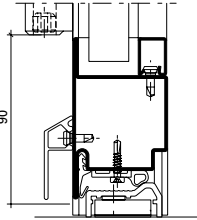
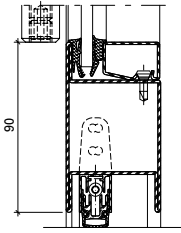
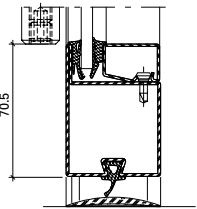
Variante	Beschlag Ferrure Fitting	 EN 12207	 EN 12208	 EN 12210
Anschlagdichtung Joint de butée Rebate gasket 	1	2	1A	C4 / C3*
	2	2	2A	C4 / C3*
	3	3	2A	C5 / C4*
Doppel-Anschlagdichtung Joint de base double Double rebate gasket 	1	4 / 3*	3A	C4 / C3*
	2	4	3A	C4 / C3*
	3	4	5A	C5 / C4*
Senkdichtung Joint seuil Drop seal 	1	2	1A	C4 / C3*
	2	2	2A	C4 / C3*
	3	3	2A	C5 / C4*
Auflaufdichtung Joint de contact Ramp seal 	1	2	0	C4 / C3*
	2	2	0	C4 / C3*
	3	2	0	C5 / C4*

* Edelstahl
 * Acier Inox
 * Stainless steel

1 Fallenriegel-Schloss
 Serrure à mortaiser
 Latch and bolt lock





2 Schloss mit Obenverriegelung
 Serrure avec verrouillage supérieur
 Lock with top locking point

3 Mehrfachverriegelungs-Schloss
 Serrure à verrouillage multiple
 Multipoint lock

Einflügelige Türen,
 einwärts öffnend,
 Flügelhöhe ≤ 2200 mm

Porte à un vantail,
 ouvrant vers l'intérieur,
 hauteur du vantail ≤ 2200 mm

Single leaf door,
 inward opening,
 leaf height ≤ 2200 mm

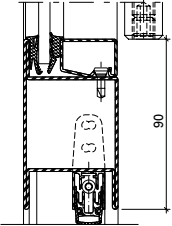
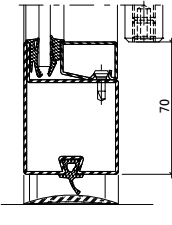
Variante		Beschlag Ferrure Fitting	 EN 12207	 EN 12208	 EN 12210
Senkdichtung Joint seuil Drop seal		❶	2	0	C4 / C3*
		❷	2	0	C4 / C3*
		❸	3	1A	C5 / C4*
Auflaufdichtung Joint de contact Ramp seal		❶	2	0	C4 / C3*
		❷	2	0	C4 / C3*
		❸	2	0	C5 / C4*

* Edelstahl
 * Acier Inox
 * Stainless steel

❶ Fallenriegel-Schloss
 Serrure à mortaiser
 Latch and bolt lock



❷ Schloss mit Obenverriegelung
 Serrure avec verrouillage supérieur
 Lock with top locking point

❸ Mehrfachverriegelungs-Schloss
 Serrure à verrouillage multiple
 Multipoint lock

Einflügelige Türen,
 auswärts öffnend,
 Flügelhöhe ≤ 3000 mm

Porte à un vantail,
 ouvrant vers l'extérieur,
 hauteur du vantail ≤ 3000 mm

Single leaf door,
 outward opening,
 leaf height ≤ 3000 mm

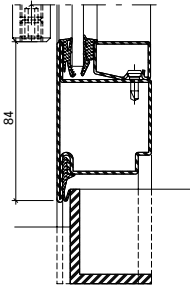
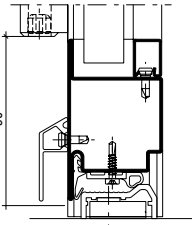
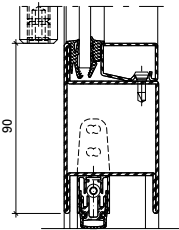
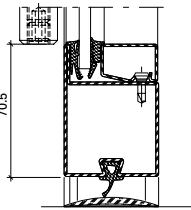
Variante	Beschlag Ferrure Fitting	 EN 12207	 EN 12208	 EN 12210
Anschlagdichtung Joint de butée Rebate gasket 	1	1	0	C1
	2	1	0	C1
	3	1	0	C2
Doppel-Anschlagdichtung Joint de base double Double rebate gasket 	1	1	1A	C1
	2	1	1A	C1
	3	2	2A	C2
Senkdichtung Joint seuil Drop seal 	1	1	0	C1
	2	1	0	C1
	3	1	0	C2
Auflaufdichtung Joint de contact Ramp seal 	1	0	0	C1
	2	0	0	C1
	3	1	0	C2

1 Fallenriegel-Schloss
 Serrure à mortaiser
 Latch and bolt lock





2 Schloss mit Obenverriegelung
 Serrure avec verrouillage supérieur
 Lock with top locking point

3 Mehrfachverriegelungs-Schloss
 Serrure à verrouillage multiple
 Multipoint lock

Einflügelige Türen,
 einwärts öffnend,
 Flügelhöhe ≤ 3000 mm

Porte à un vantail,
 ouvrant vers l'intérieur,
 hauteur du vantail ≤ 3000 mm

Single leaf door,
 inward opening,
 leaf height ≤ 3000 mm

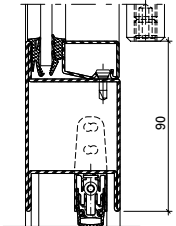
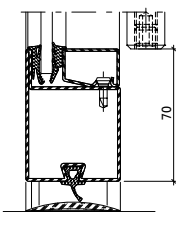
Variante		Beschlag Ferrure Fitting	 EN 12207	 EN 12208	 EN 12210
Senkdichtung Joint seuil Drop seal		❶	1	0	C1
		❷	1	0	C1
		❸	1	0	C2
Auflaufdichtung Joint de contact Ramp seal		❶	0	0	C1
		❷	0	0	C1
		❸	1	0	C2

❶ Fallenriegel-Schloss
 Serrure à mortaiser
 Latch and bolt lock



❷ Schloss mit Obenverriegelung
 Serrure avec verrouillage supérieur
 Lock with top locking point

❸ Mehrfachverriegelungs-Schloss
 Serrure à verrouillage multiple
 Multipoint lock

Zweiflügelige Türen,
 auswärts öffnend,
 Flügelhöhe ≤ 2200 mm

Porte à deux vantaux,
 ouvrant vers l'extérieur,
 hauteur du vantail ≤ 2200 mm

Double leaf door,
 outward opening,
 leaf height ≤ 2200 mm

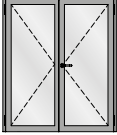
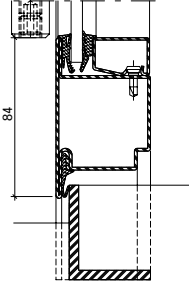
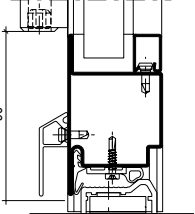
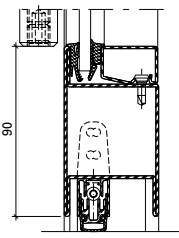
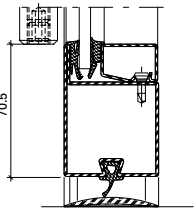
Variante	Beschlag Ferrure Fitting	 EN 12207	 EN 12208	 EN 12210
				
Anschlagdichtung Joint de butée Rebate gasket 	1	2	1A / 0*	C2
	2	2	2A / 0*	C2
	3	2	2A / 1A*	C3
Doppel-Anschlagdichtung Joint de base double Double rebate gasket 	1	2	2A	C2
	2	2	2A	C2
	3	3	3A	C3
Senkdichtung Joint seuil Drop seal 	1	2	1A / 0*	C2
	2	2	2A / 0*	C2
	3	2	2A / 1A*	C3
Auflaufdichtung Joint de contact Ramp seal 	1	2	0	C2
	2	2	0	C2
	3	2	0	C3

* Edelstahl
 * Acier Inox
 * Stainless steel

1 Fallenriegel-Schloss
 Serrure à mortaiser
 Latch and bolt lock





2 Schloss mit Oberverriegelung
 Serrure avec verrouillage supérieur
 Lock with top locking point

3 Mehrfachverriegelungs-Schloss
 Serrure à verrouillage multiple
 Multipoint lock

Zweiflügelige Türen,
 einwärts öffnend,
 Flügelhöhe ≤ 2200 mm

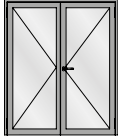
Porte à deux vantaux,
 ouvrant vers l'intérieur,
 hauteur du vantail ≤ 2200 mm

Double leaf door,
 inward opening,
 leaf height ≤ 2200 mm

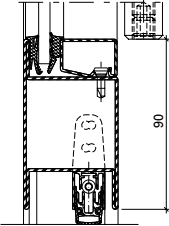
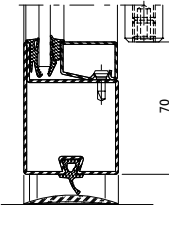
Variante		Beschlag Ferrure Fitting	 EN 12207	 EN 12208	 EN 12210
Senkdichtung Joint seuil Drop seal		❶	2	0	C2
		❷	2	0	C2
		❸	2	0	C3
Auflaufdichtung Joint de contact Ramp seal		❶	2	0	C2
		❷	2	0	C2
		❸	2	0	C3

❶ Fallenriegel-Schloss
 Serrure à mortaiser
 Latch and bolt lock



❷ Schloss mit Obenverriegelung
 Serrure avec verrouillage supérieur
 Lock with top locking point

❸ Mehrfachverriegelungs-Schloss
 Serrure à verrouillage multiple
 Multipoint lock

Zweiflügelige Türen,
 auswärts öffnend,
 Flügelhöhe ≤ 3000 mm

Porte à deux vantaux,
 ouvrant vers l'extérieur,
 hauteur du vantail ≤ 3000 mm

Double leaf door,
 outward opening,
 leaf height ≤ 3000 mm

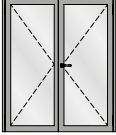
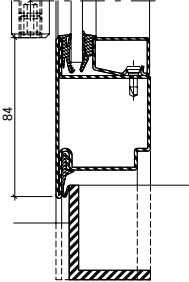
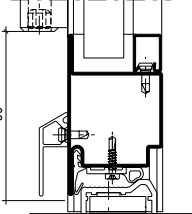
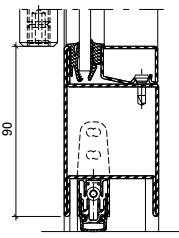
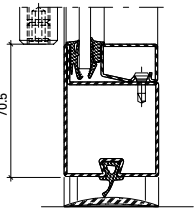
Variante	Beschlag Ferrure Fitting	 EN 12207	 EN 12208	 EN 12210
				
Anschlagdichtung Joint de butée Rebate gasket 	1	0	0	C1
	2	0	0	C1
	3	1	0	C2
Doppel-Anschlagdichtung Joint de base double Double rebate gasket 	1	1	0	C1
	2	1	0	C1
	3	2	0	C2
Senkdichtung Joint seuil Drop seal 	1	0	0	C1
	2	0	0	C1
	3	1	0	C2
Auflaufdichtung Joint de contact Ramp seal 	1	0	0	C1
	2	0	0	C1
	3	1	0	C2

* Edelstahl
 * Acier Inox
 * Stainless steel

1 Fallenriegel-Schloss
 Serrure à mortaiser
 Latch and bolt lock





2 Schloss mit Obenverriegelung
 Serrure avec verrouillage supérieur
 Lock with top locking point

3 Mehrfachverriegelungs-Schloss
 Serrure à verrouillage multiple
 Multipoint lock

Zweiflügelige Türen,
 einwärts öffnend,
 Flügelhöhe ≤ 3000 mm

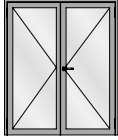
Porte à deux vantaux,
 ouvrant vers l'intérieur,
 hauteur du vantail ≤ 3000 mm

Double leaf door,
 inward opening,
 leaf height ≤ 3000 mm

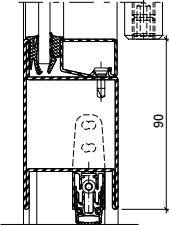
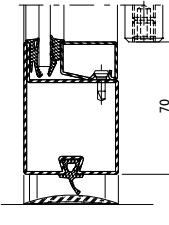
Variante		Beschlag Ferrure Fitting	 EN 12207	 EN 12208	 EN 12210
Senkdichtung Joint seuil Drop seal		❶	0	0	C1
		❷	0	0	C1
		❸	1	0	C2
Auflaufdichtung Joint de contact Ramp seal		❶	0	0	C1
		❷	0	0	C1
		❸	1	0	C2

❶ Fallenriegel-Schloss
 Serrure à mortaiser
 Latch and bolt lock

❷ Schloss mit Obenverriegelung
 Serrure avec verrouillage supérieur
 Lock with top locking point

❸ Mehrfachverriegelungs-Schloss
 Serrure à verrouillage multiple
 Multipoint lock

U_f-Werte
(nach EN ISO 10077-2:2018-01)

Valeurs U_f
(selon EN ISO 10077-2:2018-01)

U_f values
(according to
EN ISO 10077-2:2018-01)

Auf den folgenden Seiten finden Sie die U_f-Werte für die verschiedenen Anwendungen von Jansen-Economy 50 RS.

Vous trouverez les valeurs U_f pour les différentes applications Jansen-Economy 50 RS. dans les pages qui suivent.

On the following pages you will find the U_f values for the various applications for Jansen-Economy 50 RS.

Sie basieren auf folgenden Grundlagen:

Elles se basent sur les principes suivants:

They are based on the following:

Stahl

- Profile bandverzinkter Stahl, unbeschichtet
- Stahl-Glasleisten
- Trockenverglasung
- Nassverglasung

Acier

- Profilés en bande d'acier zingué, sans revêtement
- Parcloses en acier
- Vitrage à sec
- Vitrage à mastic

Steel

- Strip galvanised steel profiles, uncoated
- Steel glazing beads
- Glazing with dry glazing
- Glazing with sealing

Edelstahl

- Profile Edelstahl, blank
- Edelstahl-Glasleisten
- Trockenverglasung
- Nassverglasung

Acier Inox

- Profilés en acier Inox, brut
- Parcloses en acier Inox
- Vitrage à sec
- Vitrage à mastic









Stainless steel

- Stainless steel profiles, bright
- Stainless steel glazing beads
- Glazing with dry glazing
- Glazing with sealing

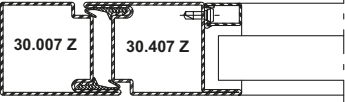
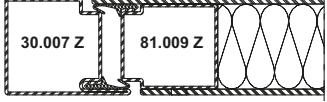
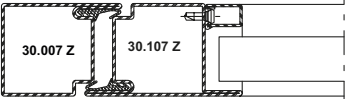
U_f-Werte
 (nach EN ISO 10077-2:2018-01)

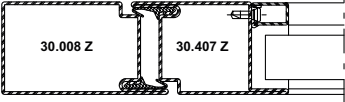
Valeurs U_f
 (selon EN ISO 10077-2:2018-01)

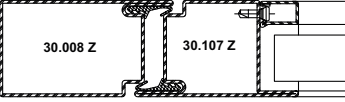

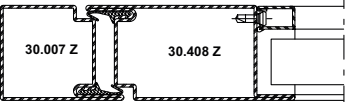
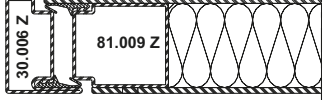
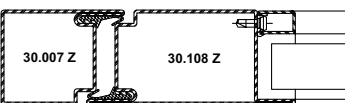
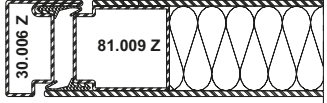
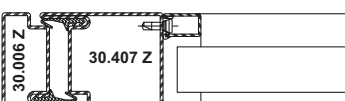
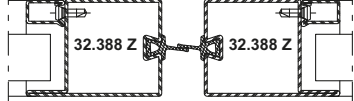
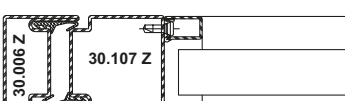
U_f values
 (according to EN ISO 10077-2:2018-01)



	Füllelementstärken Elements de remplissages Infill elements ≥ 24 mm		Füllelementstärken Elements de remplissages Infill elements ≥ 24 mm
	5,4 W/m ² K		5,3 W/m ² K
	5,4 W/m ² K		5,3 W/m ² K
	5,2 W/m ² K		5,1 W/m ² K
	5,2 W/m ² K		5,1 W/m ² K
	5,1 W/m ² K		5,4 W/m ² K
	5,2 W/m ² K		5,4 W/m ² K
	5,5 W/m ² K		6,6 W/m ² K
	5,5 W/m ² K		

U_f-Werte
 (nach EN ISO 10077-2:2018-01)

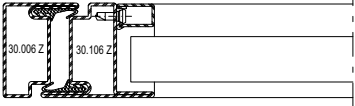
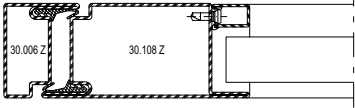
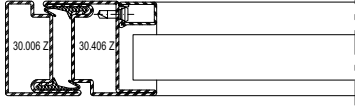
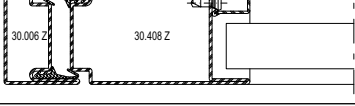
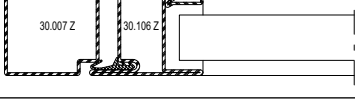
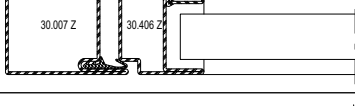
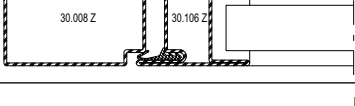
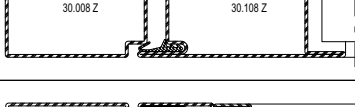
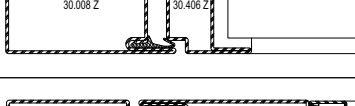
Valeurs U_f
 (selon EN ISO 10077-2:2018-01)

U_f values
 (according to EN ISO 10077-2:2018-01)

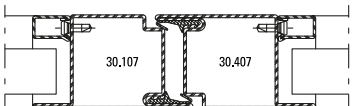
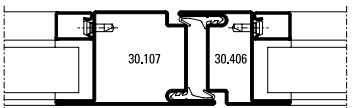
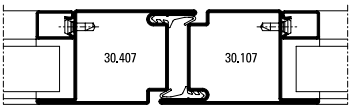
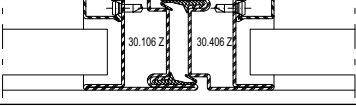
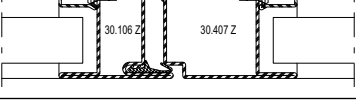
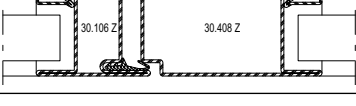
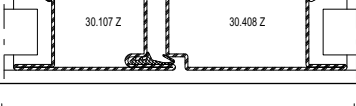
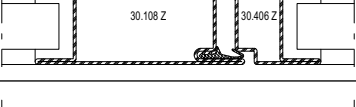
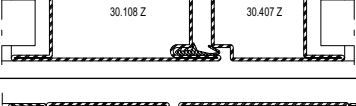
	Füllelementstärken Elements de remplissages Infill elements ≥ 24 mm
	5,8 W/m²K
	5,2 W/m²K
	5,8 W/m²K
	5,1 W/m²K
	5,6 W/m²K
	5,6 W/m²K
	5,3 W/m²K
	5,0 W/m²K
	5,3 W/m²K
	5,0 W/m²K

	Füllelementstärken Elements de remplissages Infill elements ≥ 24 mm
	5,5 W/m²K
	5,8 W/m²K
	5,6 W/m²K
	6,1 W/m²K
	5,8 W/m²K
	5,4 W/m²K
	5,3 W/m²K
	5,5 W/m²K
	5,3 W/m²K
	5,1 W/m²K

U_f-Werte
 (nach EN ISO 10077-2:2018-01)

Valeurs U_f
 (selon EN ISO 10077-2:2018-01)

U_f values
 (according to EN ISO 10077-2:2018-01)

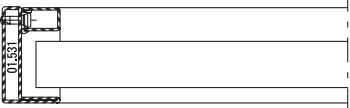
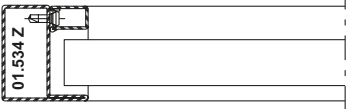
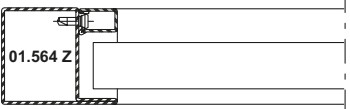
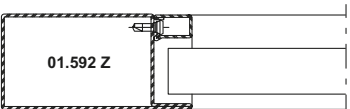
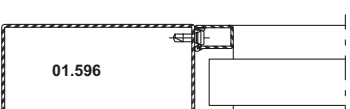
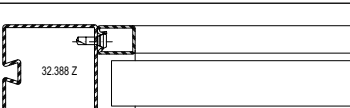
	Füllelementstärken Elements de remplissages Infill elements ≥ 24 mm
	7,3 W/m²K
	6,5 W/m²K
	6,0 W/m²K
	5,2 W/m²K
	4,9 W/m²K
	5,8 W/m²K

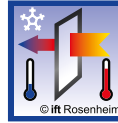
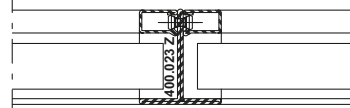
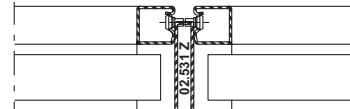
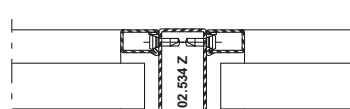
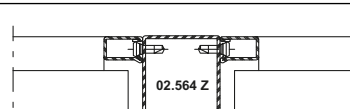
	Füllelementstärken Elements de remplissages Infill elements ≥ 24 mm
	7,5 W/m²K
	7,2 W/m²K
	6,6 W/m²K
	6,1 W/m²K

U_f-Werte
 (nach EN ISO 10077-2:2018-01)

Valeurs U_f
 (selon EN ISO 10077-2:2018-01)

U_f values
 (according to EN ISO 10077-2:2018-01)

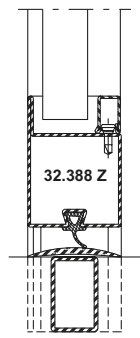
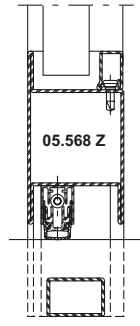
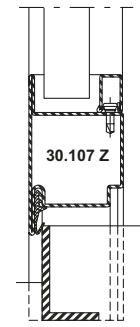
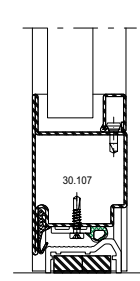
	Füllelementstärken Elements de remplissages Infill elements ≥ 24 mm
	6,8 W/m ² K
	5,4 W/m ² K
	5,6 W/m ² K
	5,6 W/m ² K

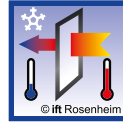
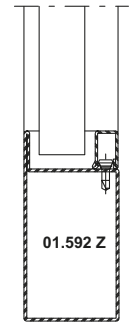
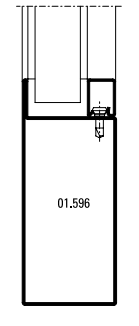
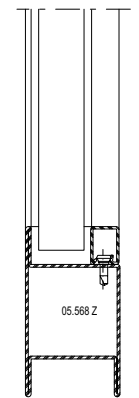

	Füllelementstärken Elements de remplissages Infill elements ≥ 24 mm
	5,2 W/m ² K
	4,9 W/m ² K
	5,6 W/m ² K

U_f-Werte
 (nach EN ISO 10077-2:2018-01)

Valeurs U_f
 (selon EN ISO 10077-2:2018-01)

U_f values
 (according to EN ISO 10077-2:2018-01)

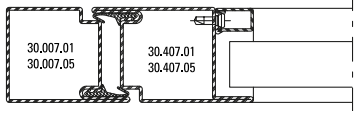
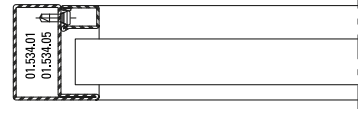
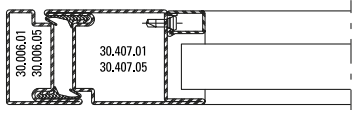
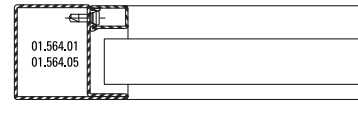
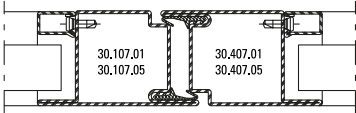
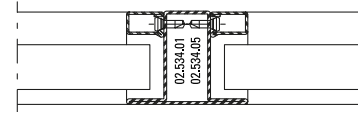
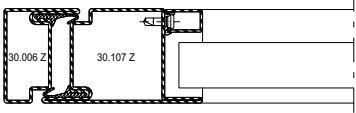
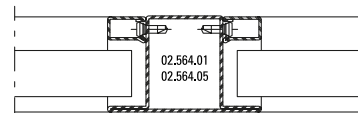
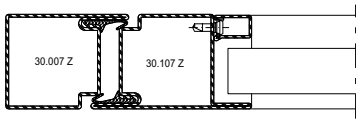

 Füllelementstärken Elements de remplissages Infill elements ≥ 24 mm		 Füllelementstärken Elements de remplissages Infill elements ≥ 24 mm	
	4,4 W/m ² K		5,6 W/m ² K
	4,6 W/m ² K		5,0 W/m ² K
	4,6 W/m ² K		5,5 W/m ² K
	4,7 W/m ² K		5,0 W/m ² K
	4,5 W/m ² K		

U_f-Werte
 (nach EN ISO 10077-2:2018-01)

Valeurs U_f
 (selon EN ISO 10077-2:2018-01)

U_f values
 (according to EN ISO 10077-2:2018-01)



<p>© ift Rosenheim</p>	<p>Füllelementstärken Elements de remplissages Infill elements</p> <p>≥ 24 mm</p>
	<p>4,5 W/m²K</p>

<p>© ift Rosenheim</p>	<p>Füllelementstärken Elements de remplissages Infill elements</p> <p>≥ 24 mm</p>
	<p>4,4 W/m²K</p>
	<p>4,7 W/m²K</p>



Schallschutz

Ausführungsvarianten

Die nachfolgende Typenübersicht ergibt einen Überblick über die beurteilten Varianten.

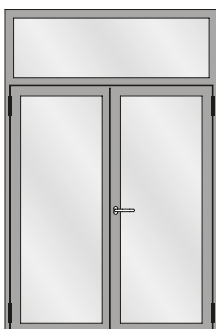
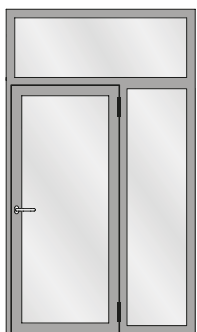
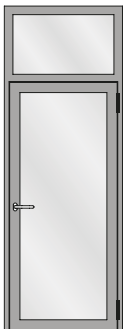
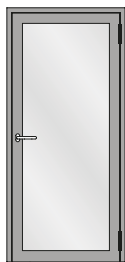

Isolation phonique

Modèles

L'aperçu des types suivant fournit une vue d'ensemble des variantes examinées.

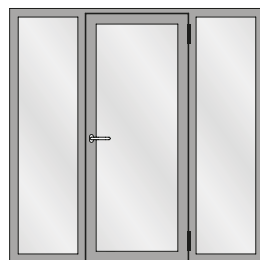
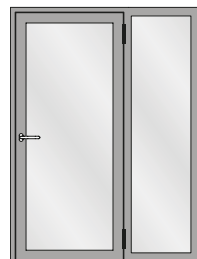
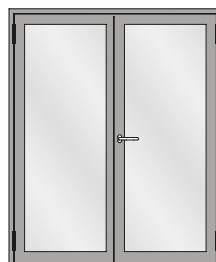

Sound insulation

Design range

The following overview of types provides an overview of the evaluated designs.

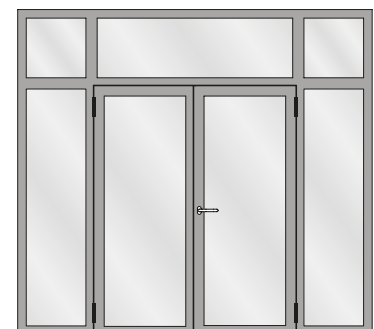
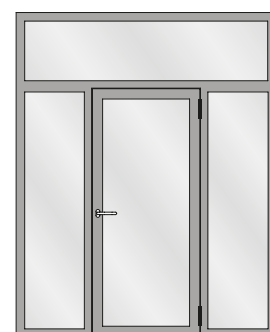

Schallschutz

Isolation phonique

Sound insulation

Tabelle A1

Korrekturtabelle für Jansen-Economy-Türen mit Glasfüllungen

Tableau A1

Tableau de correction pour les portes Jansen-Economy avec vitrage

Table A1

Correction table for Jansen-Economy doors with glass

	1	2	3	4	5	6	7	8	9	10	11
	Türe mit zwei absenkba- ren Bodendichtungen Porte avec deux joint seuil automatique Door with two threshold gaskets that can be lowered R_w (C, Ctr) dB	Glas Verre Glass $R_{w, P, Glas}$ dB	Korrekturen Corrections Corrections								
			K_S dB	K_{FV} dB	K_{Nass} dB	K_{1aB} dB	$K_{W/S}$ dB	$K_{G 0,4}$ dB	$K_{G 1,8}$ dB	$K_{G 2,6}$ dB	$K_{G 3,2}$ dB
1	32 (-1; -5)	31	0	-1	0	0	0	0	-1	-2	-3
2	33 (-1; -5)	32	0	-1	0	0	0	0	-1	-2	-3
3	35 (-1; -5)	34	0	-1	0	0	0	0	-1	-2	-3
4	36 (-2; -5)	35	0	-1	-1	0	0	0	-1	-2	-3
5	37 (-2; -5)	37	0	0	-1	0	-1	0	-1	-2	-3
6	38 (-2; -5)	39	0	0	-1	-1	-1	0	-1	-2	-3
7	39 (-2; -5)	40	0	0	-1	-1	-1	0	-1	-2	-3
8	40 (-2; -5)	41	0	0	-1	-1	-2	-1	-1	-2	-3
9	41 (-2; -5)	42	0	0	-1	-1	-2	-2	-1	-2	-3
10	42 (-2; -5)	43	-1	0	-1	-1	-2	-2	-1	-2	-3
11	42 (-2; -5)	44	-1	0	-1	-1	-2	-2	-1	-2	-3
12	43 (-2; -5)	45	-1	+1	-1	-1	-3	-3	-1	-2	-3
13	44 (-2; -5)	49	-1	+1	-1	-2	-3	-3	-1	-2	-3

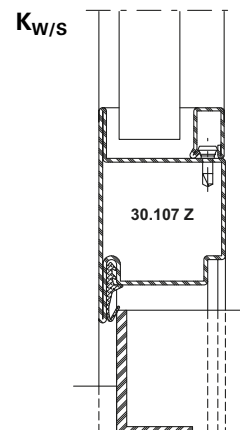
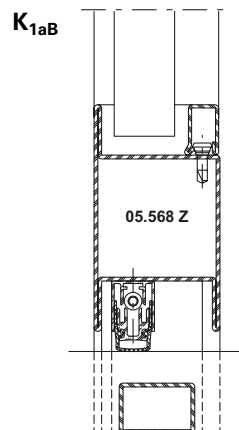
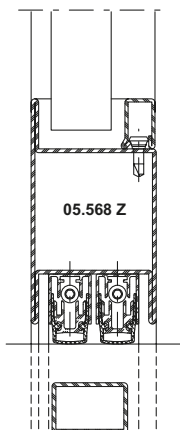

Schallschutz

Der aus der Tabelle A1 abzulesende Wert für die Schalldämmung $R_{w, Tür}$ beträgt:

Isolation phonique

La valeur à relever sur le tableau A1 concernant l'isolement contre les sons aériens $R_{w, Porte}$ est la suivante:

Sound insulation

The value taken from table A1 for the sound insulation $R_{w, Door}$ is:

$$R_{w, Tür} = R_w + K_S + K_{FV} + K_{Nass} + K_{1aB} + K_{W/S} + K_{Band} + K_{G 0,4} + K_{G 1,8} + K_{G 2,6} + K_{G 3,2} \text{ dB}$$

- R_w** bewertetes Schalldämm-Mass der Türe in Abhängigkeit von der Schalldämmung $R_{w,P, Glas}$
- $R_{w,P, Glas}$** bewertetes Schalldämm-Mass der Verglasung (Prüfwert nach ISO 140-3, mit Prüfnachweis einer PÜZ-Stelle). Alternativ können Tabellenwerte nach DIN EN 12758, Abschnitt 6 verwendet werden
- K_S** Korrekturwert für zweiflügelige Türen
- K_{FV}** Korrekturwert für Festverglasungen mit erhöhtem Scheibenanteil
- K_{Nass}** Korrekturwert für Nassverglasung
- K_{1aB}** Korrekturwert für Türen mit einer absenkbaren Bodendichtung
- K_{Band}** Korrekturwert bei Verwendung von Anschlagbändern, die eine Dichtungsebene unterbrechen ($K_{Band} = - 0,5 \text{ dB pro Band}$)
- $K_{W/S}$** Korrekturwert für Türen mit einer Anschlagsschwelle
- $K_{G 0,4}$** Korrekturwert für Einzelscheiben mit einer Glasfläche $\leq 0,4 \text{ m}^2$. Die Korrektur gilt auch für Konstruktionen mit glasteilenden Sprossen.
- $K_{G 1,8}$** Korrekturwert für Einzelscheiben mit einer Glasfläche $\geq 1,8 \text{ m}^2$
- $K_{G 2,6}$** Korrekturwert für Einzelscheiben mit einer Glasfläche $\geq 2,6 \text{ m}^2$
- $K_{G 3,2}$** Korrekturwert für Einzelscheiben mit einer Glasfläche $\geq 3,2 \text{ m}^2$

- R_w** Mesure d'isolement contre les sons aériens des portes évaluée suivant l'isolement phonique $R_{w,P, Glas}$
- $R_{w,P, Glas}$** Cote d'isolement acoustique du vitrage évalué (valeur contrôlée selon ISO 140-3 avec certificat d'un bureau de contrôle, de surveillance ou de certification). Il est également possible d'utiliser les valeurs selon le tableau DIN EN 12758, section 6
- K_S** Valeur de correction pour portes à deux vantaux
- K_{FV}** Valeur de correction pour vitrages fixes à fort pourcentage de vitre
- K_{Nass}** Valeur de correction pour vitrage avec mastic
- K_{1aB}** Valeur de correction pour portes avec un joint seuil automatique
- K_{Band}** Valeur corrective en cas d'utilisation de paumelles qui interrompent un plan d'étanchéité ($K_{Band} = - 0,5 \text{ dB par paumelle}$)
- $K_{W/S}$** Valeur de correction pour portes avec un seuil de butée
- $K_{G 0,4}$** Valeur de correction pour vitres individuelles avec une surface vitrée $\leq 0,4 \text{ m}^2$. La correction s'applique aussi aux constructions à meneaux séparant les vitres.
- $K_{G 1,8}$** Valeur de correction pour vitres individuelles avec surface vitrée $\geq 1,8 \text{ m}^2$
- $K_{G 2,6}$** Valeur de correction pour vitres individuelles avec surface vitrée $\geq 2,6 \text{ m}^2$
- $K_{G 3,2}$** Valeur de correction pour vitres individuelles avec surface vitrée $\geq 3,2 \text{ m}^2$

- R_w** Airborne sound reduction index of doors depending on the sound insulation $R_{w,P, Glas}$
- $R_{w,P, Glas}$** Airborne sound reduction index (test value in accordance with ISO 140-3, with a test certificate from a recognised testing, inspection or certification body). Alternatively, the tabulated values in DIN EN 12758, Section 6 may be used
- K_S** Correction value for double-leaf doors
- K_{FV}** Correction value for fixed glazing with increased proportion of pane
- K_{Nass}** Correction value for glazing with sealing
- K_{1aB}** Correction value for doors with a threshold gasket that can be lowered
- K_{Band}** Correction value when using hinges that interrupt a sealing plane ($K_{Band} = - 0.5 \text{ dB per hinge}$)
- $K_{W/S}$** Correction value for doors with a rebate threshold
- $K_{G 0,4}$** Correction value for single panes with a glass area $\leq 0,4 \text{ m}^2$. The correction also applies to buildings with glazing bars
- $K_{G 1,8}$** Correction value for single panes with a glass area $\geq 1,8 \text{ m}^2$
- $K_{G 2,6}$** Correction value for single panes with a glass area $\geq 2,6 \text{ m}^2$
- $K_{G 3,2}$** Correction value for single panes with a glass area $\geq 3,2 \text{ m}^2$

